

Your Brand
Ambassador

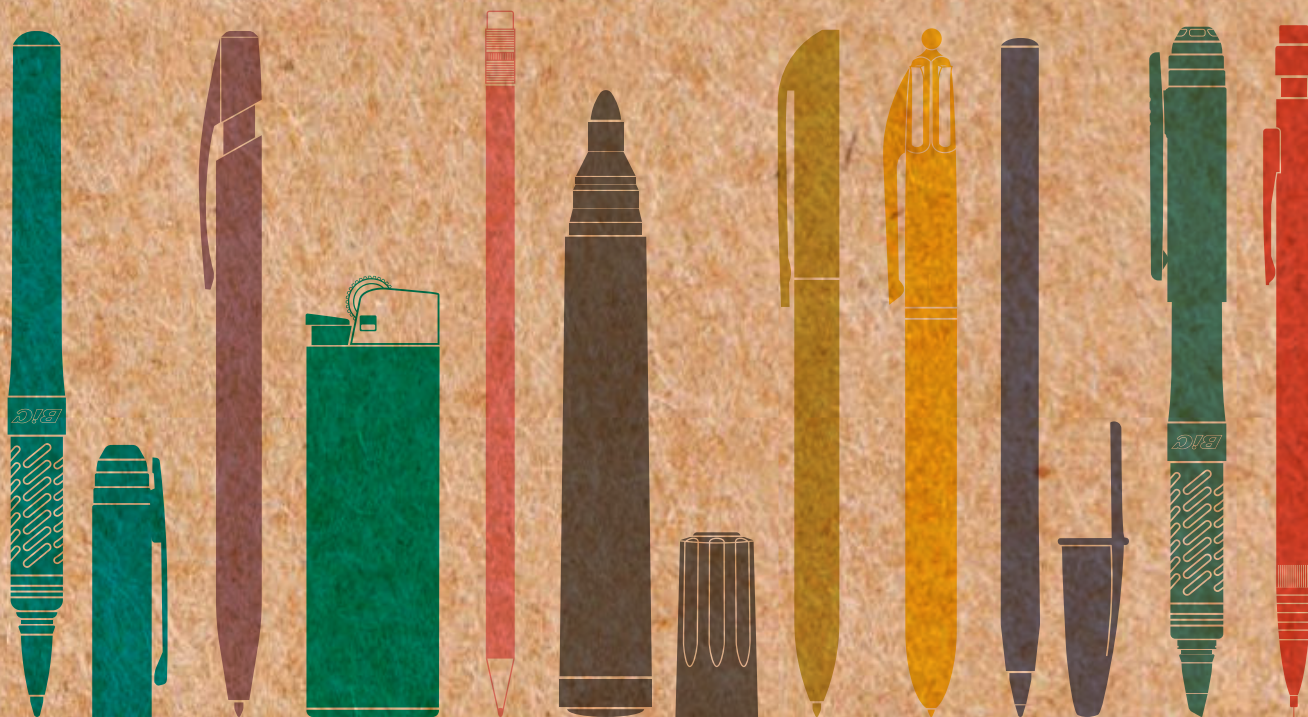

Think BIC

2023

NUOVO!

THE FUTURE IS ORIGIN

Se c'è una cosa che sappiamo del futuro è che o sarà più verde o non lo sarà. Ecco perché l'eco-design gioca un ruolo importante quando si tratta di innovazione, ed ecco perché lavoriamo in questa direzione da oltre 20 anni.

ORIGIN  **BIO BASED**



Olio di ricino di origine biologica



Segatura di legno
Dalle foreste europee gestite in modo sostenibile



Talco
Estratto in Europa



Essere o non essere

Nell'ambito dell'innovazione di prodotto e del nostro impegno per l'eco-design, stiamo aprendo una nuova fase con i prodotti **Origin** realizzati a partire da materiali di origine biologica composti da polimeri naturali, escludendo elementi provenienti dal petrolio e dai combustibili fossili.

Essere o non essere. Come noi, che siamo stati pionieri della sostenibilità fin da prima che tutti parlassero dell'importanza di essere sostenibili. Essere o non essere, questa è la domanda; e per noi è stata la domanda per molto, molto tempo.

Tecniche di stampa

TEST DI CONTROLLO QUALITÀ

I nostri inchiostri sono conformi alle normative europee. 5 test differenti:

- Adesione
- Graffio (ISO 12137:11)
- Abrasione
- Caduta
- Esposizione alla traspirazione

Ogni ordine stampato viene sottoposto a 4 differenti controlli:

- Aspetto estetico
- Colore stampato
- Controllo dell'aderenza della stampa
- Resistenza al graffio





**Con la garanzia
di oltre 50 anni
di esperienza!**

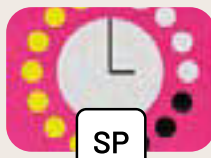

SP

Serigrafia

Tecnica perfetta per creare stampe di alta qualità, riproducendo colori accurati.



BP

BritePix™ Personalisation

Personalizzazione britePix™. Personalizza ogni unità dello stesso ordine britePix™.



BP

BritePix™ Texture

BritePix™ Texture è un salto di qualità nel nostro concetto di stampa britePix™ - ora non solo puoi vedere il colore pieno, ma puoi anche toccarlo!

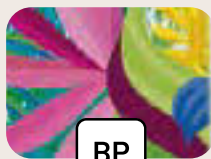

BP

BritePix™

Stampa a colori con risultati fotografici di alta qualità che garantisce una stampa duratura del tuo logo.



BP

BritePix™ Digital

La soluzione per la comunicazione a tutto colore. Ora sui fusti colorati.

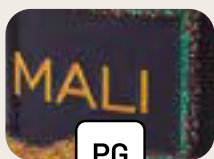

PG

Puffy Glitter

Impreziosisci i tuoi disegni con l'effetto lucido del glitter. Guarda e senti la sua texture lucida e colorata!



P

Puffy

Metti in risalto il tuo marchio con il nostro effetto "puffy" che dà rilievo al tuo logo.

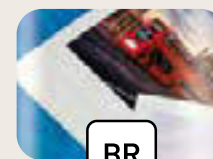

BR

Brilliant

Scegli la finitura lucida per un effetto finale abbagliante.



M

Metallic

Crea splendidi effetti metallici su testi, immagini e sfondi!



H

Holographic

Fatti notare tra la folla! Gioca con gli attraenti riflessi in oro o argento nel tuo disegno.



MT

Matt

Utilizza la finitura opaca per aggiungere un tocco di eleganza al tuo design.



UV

UV

Metti in risalto il tuo marchio con una finitura lucida! Combina opaco e lucido per evidenziare i contrasti.

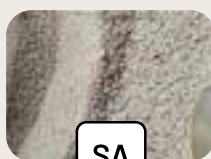

SA

Sandy

Crea un effetto sabbia con una texture granulata.

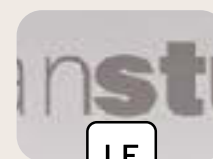

LE

Laser

L'incisione laser ti permetterà di dare un effetto elegante alle tue comunicazioni. Usala e ottieni una stampa duratura.

La soluzione per una Comunicazione full-colour



BIC GRAPHIC EUROPE PIONIERE NELLA
STAMPA DIGITALE



BritePix™ Texture

BritePix™ Texture è un salto di qualità nel nostro concetto di stampa britePix™ - ora non solo puoi vedere il colore pieno, ma puoi anche toccarlo!



BritePix™

Il messaggio puo' essere stampato a colori con l'eccellente risoluzione fotografica che assicura un'impressione durevole e vibrante del vostro logo.



BritePix™ Digital

La soluzione per la comunicazione a tutto colore. Ora sui fusti colorati.



BritePix™ Personalisation

Personalizzazione britePix™. Personalizza ogni unità dello stesso ordine britePix™



BIC® Evolution® Evolutions®



BIC® Media Clic



BIC® Round Stic®



BIC® Clic Stic



BIC® Wide Body™



BIC® 4 Colours®



BIC® Super Clip Advance



Area stampa
360°



Full-colour



Qualità
fotografica



Definizione HD



Colori illimitati
e migliorati

BIC Graphic impegnata nella salvaguardia dell'ambiente



Prodotto dalla lavorazione di scarti di vassoi di frutta e verdura.

**BIC® WIDE BODY™
ECOLUTIONS®**

**BIC® CLIC STIC
ECOLUTIONS®**

**BIC® ROUND STIC®
ECOLUTIONS®**



Prodotto con scarti farmaceutici.

**BIC® PERMANENT
MARKER
ECOLUTIONS®**

**BIC® MATIC®
ECOLUTIONS®**



Prodotto dalla lavorazione di scarti di componenti plastici delle automobili.

**BIC® MEDIA CLIC
GRIP ECOLUTIONS®**

**BIC® MEDIA CLIC
ECOLUTIONS®**

**BIC® SUPER CLIP
ECOLUTIONS®**

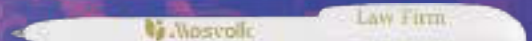
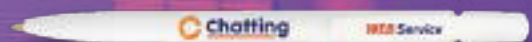
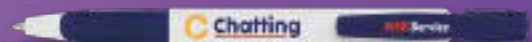

**LA NOSTRA GAMMA
ECOLUTIONS, PRODOTTA
CON MATERIALI ECOLOGICI**

- Materiali riciclati e riciclabili
- Materiale Bio-Based
- Carta proveniente da foreste sostenibili (FSC)
- Carta riciclata



**BIC® MEDIA CLIC
BIO-BASED
ECOLUTIONS®**

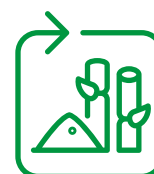

A base di canna da zucchero.



**SPROUT™
MATITA IN GRAFITE**



Cartone FSC e riciclabile.



**BIC® EVOLUTION®
ECOLUTIONS®**



Fabbricato da scarti di frigoriferi riciclati e dal materiale in eccesso della produzione di vasetti di yogurt.

BIC® packaging Ecolutions®, confezione sostenibile

L'era delle buone intenzioni è finita da tempo. Siamo entrati nell'era dei fatti. Nel 2004, BIC® ha lanciato il primo piano di sviluppo sostenibile. Ciò ha dato origine a una serie di principi che oggi sono più attuali che mai. E questo ha portato ai fatti. Come le soluzioni più sostenibili per il nostro packaging, realizzato con materiale riciclato al 100%, progettato per essere riutilizzabile e con l'obiettivo di ridurre l'impronta ecologica.

VALORE ECOLOGICO

- Riduce e ottimizza i materiali riciclati e riciclabili.
- Riduce l'impatto ambientale.
- Progettati per molteplici usi.

MATERIALI CERTIFICATI

- 100% di cartone riciclato.
- Plastiche come PET, PP o PS 100% riciclabili.
- Materie prime provenienti da foreste sostenibili (FSC).

Per ulteriori informazioni,
vedere pagina 222.

VALORE SOCIALE

- Supporto di progetti agricoli per la popolazione locale in Kenya.



Gli imballaggi con il logo Treedom® contribuiscono alla creazione della BIC Graphic Forest in Kenya. Grazie al vostro contributo, attraverso questa campagna, potremo migliorare l'ambiente (riducendo l'impatto ambientale) e sostenere progetti agroforestali che contribuiscono a migliorare gli ecosistemi rendendoli sostenibili.



Cartone riciclato / riciclabile
Plastica riciclabile



Materiali rispettosi
dell'ambiente



-90,100 KG CO₂
Gli alberi che abbiamo
scelto di piantare
assorbono dall'atmosfera
una quantità di CO₂ che
basterebbe a riempire ben
469 tir.



Prodotto In Spagna



Nuove confezioni speciali per prodotti BIC®

Scatola in cartone FSC. Personalizzabile su ogni lato, offre grandi superfici di comunicazione. Ideale per presentare i nostri iconici prodotti BIC® in una collezione. Più che una penna, un ottimo modo per ottimizzare le tue vendite.

BIC® COLLECTION BOX

Confezione speciale per:

- BIC® 4 COLOURS®**
- BIC® WIDE BODY™**
- BIC® SUPER CLIP**
- BIC® BRITE LINER® GRIP**
- BIC® GRIP ROLLER**



**BIC® COLLECTION
BOX 1 UNITÀ**
991212

**BIC® COLLECTION
BOX 2 UNITÀ**
991213

**BIC® COLLECTION
BOX 3 UNITÀ**
991214

Introduzione di un nuovo servizio di ricarica per la tua penna a sfera.

Pensa alla piacevole sensazione di avere tra le mani la penna perfetta per te. La usi così tanto che alla fine finisci per rimanere senza inchiostro. Quindi ora pensa che potrai prolungare la durata della tua BIC® 4 Colours® o della tua BIC® Super Clip Advance, con il nostro nuovo servizio di ricarica. Se ci pensi bene, è una soluzione sostenibile, coerente con il nostro modo di pensare. Se ci pensi bene, non dovrebbe sorprenderti. Eppure...



BIC® SUPER CLIP ADVANCE

BIC® 4 COLOURS®

Servizio di ricarica su richiesta.
Chiedi al tuo rappresentante vendite informazioni su questo nuovo servizio.

NUOVO!

Ricicla



BIC® STYLE

**Facilmente
riconoscibile in tutto
il mondo per il suo
iconico tappo.**

**BIC® Style offre un
eccellente rapporto
qualità-prezzo.**



BIC® STYLE

1610 Opaco

Colore inchiostro



MARCATURA



CONFORMITÀ
NORMATIVA



IMPRIM'VERT®



RICICLABILE



100% ELETTRICITÀ
RINNOVABILE

MODALITÀ
DI SCRITTURA



PENNA A SFERA M

TECNICHE
DI STAMPA



SERIGRAFIA

BIC® STYLE
1610 Clear
Colore inchiostro



Personalizzazione

BIC® STYLE

1610 Opaco

A SP: max. 2 col.

BIC® STYLE

1610 Clear

B SP: max. 1 col.

MOQ 500 pz.

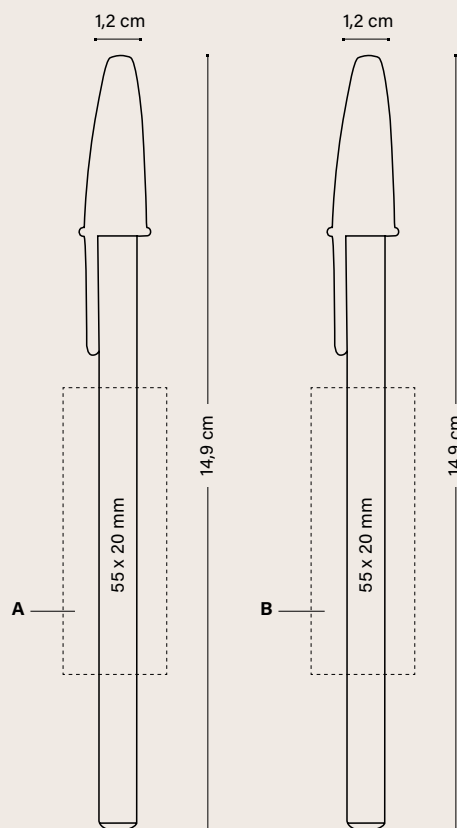

BIC® STYLE	500-999	1000-2499	2500-4999	Prezzo (€)
1610				5000
SP	0,48	0,43	0,41	0,39

Costo di stampa aggiuntivo per colore e posizione

SP	0,14	0,14	0,14	0,13
----	------	------	------	------

I prezzi includono serigrafia ad un colore in una posizione.

CONFEZIONI SPECIALI OPZIONALI IMBALLAGGIO ESTERNO



PLASTIC
POUCH

+ INFO PAG. 222-227



500 ± 3,5 KG

MARCATURA



PRODOTTO E STAMPATO
NEGLI STABILIMENTI BIC



CONFORMITÀ
NORMATIVA



ISO
certified



IMPRIM'VERT®



100%
RICICLABILE

MODALITÀ DI SCRITTURA



PENNA A SFERA M

TECNICHE DI STAMPA



SP
SERIGRAFIA

BIC® ROUND STIC®

**L'iconica BIC® Round Stic®
offre uno stile intramontabile
ed alta qualità.**

**Il suo design classico
la rende facilmente
riconoscibile ed è
prova di una longeva
affidabilità.**





*l' iconico
BIC® Boy
è inciso*

BIC® ROUND STIC®

1010 Opaco

Colore inchiostro



Inchiostro rosso disponibile su richiesta



12

05

07

18

02

03

100%
01

*Disponibile
in fusto bianco*



MARCATURA



**MIX &
MATCH**



COLORI
PERSONALIZZATI



PRODOTTO E STAMPATO
NEGLI STABILIMENTI BIC



PRODOTTO
IN SPAGNA



CONFORMITÀ
NORMATIVA



IMPRIM'VERT®



100%
RICICLABILE



100% ELETTRICITÀ
RINNOVABILE



BASSO IMPATTO
AMBIENTALE

MODALITÀ DI SCRITTURA



PENNA A SFERA M

TECNICHE DI STAMPA



SERIGRAFIA



DIGITALE

Vedere pagina 233 per una spiegazione dettagliata delle icone.

BIC® ROUND STIC®

1010 Frosted

Colore inchiostro



Inchiostro rosso disponibile su richiesta



Versione ECO.
Allo stesso prezzo della versione standard!

ecolutions®



REALIZZATA CON IL 94%
DI MATERIALE RICICLATO**

VASSI DI
FRUTTA
E VERDURA



MARCATURA



MIX &
MATCH



COLORI
PERSONALIZZATI



PRODOTTO E STAMPATO
NEGLI STABILIMENTI BIC



PRODOTTO
IN SPAGNA



CONFORMITÀ
NORMATIVA



IMPRIM'VERT®

ecolutions®



VASSI DI
FRUTTA
E VERDURA



RICICLABILE



100% ELETTRICITÀ
DA FONTI RINNOVABILI



BASSO IMPATTO
AMBIENTALE

MODALITÀ DI
SCRITTURA



PENNA A SFERA M

TECNICHE
DI STAMPA



SERIGRAFIA



DIGITALE

BIC® ROUND STIC®

1E10 Opaco

Colore inchiostro



Inchiostro rosso disponibile su richiesta



1E/8E



1E/7E



1E/3E



100%

Stampa a
360°

BIC® ROUND STIC®

1E10 Frosted

Colore inchiostro



Inchiostro rosso disponibile
su richiesta



2E/8E



2E/7E



2E/3E



100%

Disponibile
in fusto bianco

britePix
DIGITAL

*Servizio 48h non disponibile per stampa digitale

**La percentuale è calcolata sul peso totale del prodotto refill escluso. A causa del contenuto riciclato delle materie prime con cui è realizzato il prodotto, non siamo in grado di garantire che i colori che appaiono in catalogo, né quelli personalizzati su richiesta, abbiano sempre lo stesso colore e aspetto

Vedere pagina 233 per una spiegazione dettagliata delle icone.

BIC® ROUND STIC®

1010 / **ecolutions®** 1E10 Opaco
 1010 / **ecolutions®** 1E10 Frosted

MOQ 500 pz.
 Combinazione colori standard

ecolutions®



Combinazione colori standard***

Tappino

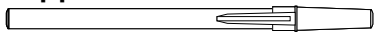

Cappuccio

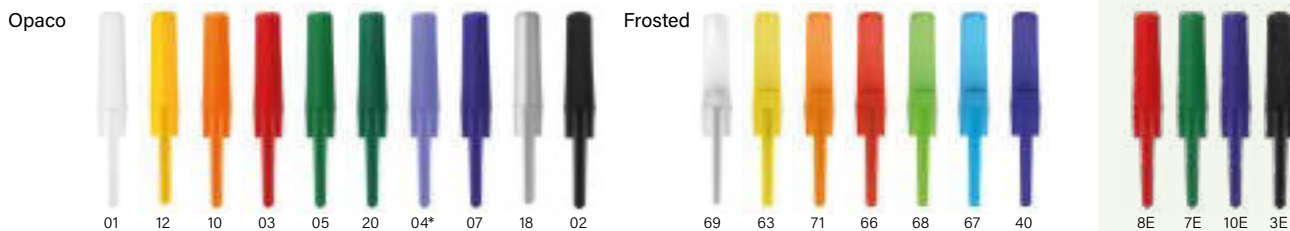
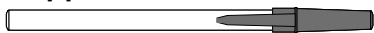

Sezione

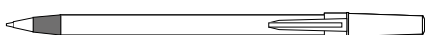

Fusto



Esatta corrispondenza di colore: ≥ 10.000 unità



Aggiungi il Mobius loop alla tua grafica senza costi aggiuntivi. Si prega di specificarlo nell'ordine. La stampa del Mobius loop viene fatta di default nell'angolo a sinistra.

*Fino ad esaurimento scorte
 **Servizio 48h non disponibile per stampa digitale
 ***A causa del contenuto riciclato delle materie prime con cui è realizzato il prodotto, non siamo in grado di garantire che i colori che appaiono in catalogo, né quelli personalizzati su richiesta, abbiano sempre lo stesso colore e aspetto

Personalizzazione

BIC® ROUND STIC®

1010

ecolutions® 1E10

A SP: max. 3 col.

B SP: max. 1 col.

C DG: full-colour

(Disponibile solo in fusto bianco)

MOQ 500 pz.

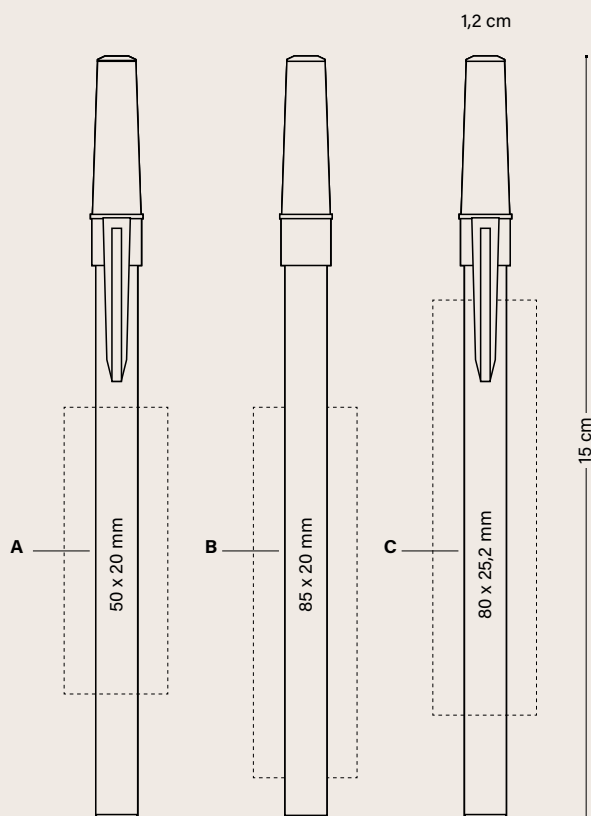

BIC® ROUND STIC®	500-999	1000-2499	2500-4999	Prezzo (€)
1010 / ecolutions® 1E10				5000
SP	0,53	0,51	0,47	0,44
DG	0,77	0,73	0,67	0,63

Costo di stampa aggiuntivo per colore e posizione

SP	0,14	0,14	0,14	0,13
----	------	------	------	------

I prezzi includono una stampa in una posizione secondo la tecnica specificata.

CONFEZIONI SPECIALI OPZIONALI



PLASTIC
POUCH

+ INFO PAG. 222-227

IMBALLAGGIO ESTERNO



500 ± 2,5 KG

MARCATURA



MIX &
MATCH



COLORI
PERSONALIZZATI



PRODOTTO E STAMPATO
NEGLI STABILIMENTI BIC



PRODOTTO
IN SPAGNA



CONFORMITÀ
NORMATIVA



ISO
certified

IMPRIM'VERT®

ecolutions®



VASSOI DI
FRUTTA
E VERDURA



100%
RICICLABILE



100% ELETTRICITÀ
DA FONTI RINNOVABILI



BASSO IMPATTO
AMBIENTALE

MODALITÀ DI
SCRITTURA



PENNA A SFERA M

TECNICHE
DI STAMPA



SP
SERIGRAFIA



DG
DIGITALE

Vedere pagina 233 per una spiegazione dettagliata delle icone.

BIC® ROUND STIC® BGUARD™ ANTIBACTERIAL

BGUARD™



Protezione batterica



Protezione della superficie della penna a sfera



Protezione permanente



Test di protocollo antibatterico



Iconico BIC® Boy e logo BIC® sempre visibili!

ANTIBACTERIAL™

BIC® ROUND STIC® BGUARD™ ANTIBACTERIAL

1011 Opaco

Colore inchiostro



Inchiostro rosso disponibile su richiesta



07BG



02BG



03BG



01BG

Disponibile in fusto bianco



MIX & MATCH

Nessun costo aggiuntivo

MOQ 500 pz.

Combinazione colori standard

Tappino

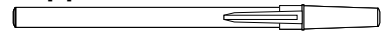

Opaco



Cappuccio

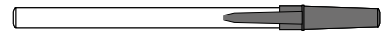

Opaco



Sezione

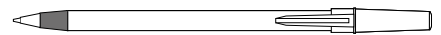

Opaco



Fusto



Opaco

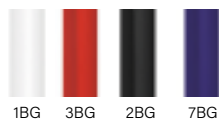

Esatta corrispondenza di colore: ≥ 10.000 pz.



*Servizio 48h non disponibile per stampa.

Disponibile in paesi selezionati, chiedere al rappresentante del servizio clienti

Personalizzazione

**BIC® ROUND STIC®
BGUARD™ ANTIBACTERIAL**

1011

A SP: max. 2 col.

B DG: full-colour

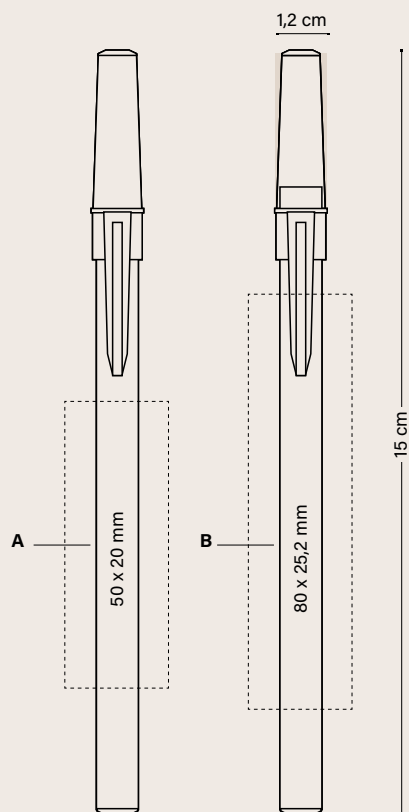

	Prezzo (€)			
BIC® ROUND STIC® BGUARD™ ANTIBACTERIAL	500-999	1000-2499	2500-4999	5000
1011				
SP	0,61	0,58	0,53	0,50
DG	0,83	0,79	0,73	0,69

Costo di stampa aggiuntivo per colore e posizione

SP	0,14	0,14	0,14	0,13
-----------	------	------	------	------

I prezzi includono una stampa in una posizione secondo la tecnica specificata.

CONFEZIONI SPECIALI OPZIONALI



PLASTIC
POUCH

+ INFO PAG. 222-227

IMBALLAGGIO ESTERNO



500 ± 2,5 KG

MARCATURA



MIX &
MATCH



COLORI
PERSONALIZZATI



PRODOTTO E STAMPATO
NEGLI STABILIMENTI BIC



PRODOTTO
IN SPAGNA



CONFORMITÀ
NORMATIVA



IMPRIM'VERT®



100%
RICICLABILE



100% ELETTRICITÀ
DA FONTI RINNOVABILI



BASSO IMPATTO
AMBIENTALE

MODALITÀ
DI SCRITTURA



PENNA A SFERA M

TECNICHE
DI STAMPA



SERIGRAFIA



DIGITALE

Vedere pagina 233 per una spiegazione dettagliata delle icone.



*Iconico BIC® Boy
e logo BIC®
sempre visibili!*

BIC® M10® CLIC

1590

Colore inchiostro



01

8G

10

14

59

04

02

3D

100%

●
Disponibile solo
in inchiostro nero

Personalizzazione

BIC® M10® CLIC
1590

A SP: max. 2 col.

MOQ 500 pz.

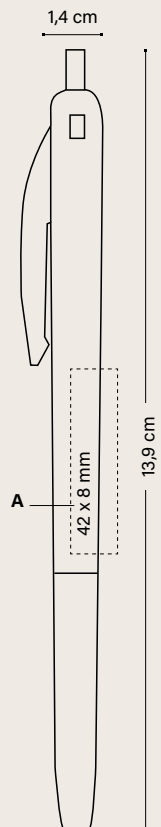

	Prezzo (€)			
BIC® M10® CLIC	500-999	1000-2499	2500-4999	5000
1590				
SP	0,58	0,56	0,52	0,49
Costo di stampa aggiuntivo per colore e posizione				
SP	0,14	0,14	0,14	0,13

I prezzi includono serigrafia ad un colore in una posizione.

CONFEZIONI SPECIALI OPZIONALI



+ INFO PAG. 222-227

IMBALLAGGIO ESTERNO



MARCATURA



PRODOTTO E STAMPATO NEGLI STABILIMENTI BIC

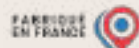

PRODOTTO IN FRANCIA



COLORE BIANCO
PRODOTTO IN SAF



CONFORMITÀ
NORMATIVA



RICICLABILE



100 % ELETTRICITÀ
DA FONTI RINNOVABILI



BASSO IMPATTO
AMBIENTALE

**MODALITÀ
DI SCRITTURA**



PENNA A SFERA M

**TECNICHE
DI STAMPA**



SERIGRAFIA



GUARDA IL VIDEO

Vedere pagina 233 per una spiegazione dettagliata delle icone.



BIC[®] MEDIA CLIC

Una tra le più vendute del settore, note per la sua funzionalità e il suo design, la nostra BIC[®] Media Clic è un prodotto durevole disponibile in diversi materiali, a scelta tra le versioni Standard, Riciclata, Bio-Based, Antibatterica e Antimicrobica.

Lasciati ispirare dall'ampia varietà di finiture e colori per mettere in risalto il tuo marchio.

Ecolutions[®]

Grip

Grip Ecolutions[®]

BGuard[™] Antibacterial

BGuard[™] Antimicrobial

Bio-Based

Bio-Based BGuard[™] Antibacterial

Shine

Glacé

Portamine



LA SOLUZIONE PER LA COMUNICAZIONE FULL COLOUR!

Ora sui nuovi corpi colorati



Anche in versione Portamine

BIC® MEDIA CLIC

1025 Penna a sfera

1028 Portamine

Lucido

Colore inchiostro



Inchiostro rosso disponibile su richiesta



←
Più di 10.000 clic! = Maggiore visibilità al tuo marchio

Stampa a 360°

100%



l' iconico BIC® Boy è inciso!



*Anche in versione
Portamine*

BIC® MEDIA CLIC

1025 Penna a sfera / 1028 Portamine
Frosted

Colore inchiostro



Inchiostro rosso disponibile su richiesta



MARCATURA



**MIX &
MATCH**



COLORI
PERSONALIZZATI



PRODOTTO E STAMPATO
NEGLI STABILIMENTI BIC



PRODOTTO
IN SPAGNA



CONFORMITÀ
NORMATIVA



IMPRI'M'VERT®



100%
RICICLABILE



100% ELETTRICITÀ
DA FONTI RINNOVABILI



BASSO IMPATTO
AMBIENTALE

MODALITÀ DI SCRITTURA



PENNA A SFERA M

TECNICHE DI STAMPA



SERIGRAFIA



DIGITALE

Vedere pagina 233 per una spiegazione dettagliata delle icone.

*Servizio 48h non disponibile per stampa
Portamine **1028** disponibile in: 3B, 63, 71, 39, 67



*l' iconico BIC® Boy
è inciso!*



*Anche in versione
Portamine*

BIC® MEDIA CLIC

1025 Penna a sfera / 1028 Portamine

Opaco

Colore inchiostro



Inchiostro rosso disponibile su richiesta





Versione ECO.
Allo stesso prezzo della versione standard!

ecolutions®

REALIZZATA CON IL 92%
DI MATERIALE RICICLATO***

PARTI IN PLASTICA
PER AUTOVEICOLI

BIC® MEDIA CLIC

1E25 Penna a sfera
Opaco

Colore inchiostro



Stampa a 360°

Disponibile
in fusto bianco



MARCATURA



MIX &
MATCH



COLORI
PERSONALIZZATI



PRODOTTO E STAMPATO
NEGLI STABILIMENTI BIC



PRODOTTO
IN SPAGNA



CONFORMITÀ
NORMATIVA



IMPRIM'VERT®

ecolutions®



PARTI IN PLASTICA
PER AUTOVEICOLI



RICICLABILE



100% ELETTRICITÀ
DA FONTI RINNOVABILI



BASSO IMPATTO
AMBIENTALE

MODALITÀ
DI SCRITTURA



PENNA A SFERA M

TECNICHE
DI STAMPA



SERIGRAFIA



DIGITALE

Vedere pagina 233 per una spiegazione dettagliata delle icone.

*Fino ad esaurimento scorte

**Servizio 48h non disponibile per stampa digitale

***La percentuale è calcolata sul peso totale del prodotto refill escluso. A causa del contenuto riciclato delle materie prime con cui è realizzato il prodotto, non siamo in grado di garantire che i colori che appaiono in catalogo, né quelli personalizzati su richiesta, abbiano sempre lo stesso colore e aspetto.

BIC® MEDIA CLIC

1025 Penna a sfera

Clear

Colore inchiostro



*Ancora in versione
Portamine*

BIC® MEDIA CLIC GRIP

1020 Penna a sfera / 1021 Portamine

Opaco

Colore inchiostro



*Disponibile
in fusto bianco*



BIC® MEDIA CLIC GRIP



Anche in versione Portamine

BIC® MEDIA CLIC GRIP

1020 Penna a sfera / 1021 Portamine

Frosted

Colore inchiostro



01/69

69/69

71/69

82/69

40/69

100%



Anche in versione Portamine

Versione ECO.
Allo stesso prezzo della versione standard!

ecolutions®



REALIZZATA CON IL 92% DI MATERIALE RICICLATO***



PARTI IN PLASTICA PER AUTOVEICOLI

BIC® MEDIA CLIC GRIP

1E20 Penna a sfera / 1E21 Portamine

Opaco

Colore inchiostro



01/12

01/03

01/05

01/02

100%



01/07

MARCATURA



MIX & MATCH



COLORI PERSONALIZZATI



PRODOTTO E STAMPATO NEGLI STABILIMENTI BIC



PRODOTTO IN SPAGNA



CONFORMITÀ NORMATIVA



IMPRIM'VERT®

ecolutions®



PARTI IN PLASTICA PER AUTOVEICOLI



RICICLABILE



100% ELETTRICITÀ DA FONTI RINNOVABILI



BASSO IMPATTO AMBIENTALE

MODALITÀ DI SCRITTURA



PENNA A SFERA M

TECNICHE DI STAMPA



SERIGRAFIA



DIGITALE

**Servizio 48h non disponibile per stampa digitale.

***La percentuale è calcolata sul peso totale del prodotto refill escluso. A causa del contenuto riciclato delle materie prime con cui è realizzato il prodotto, non siamo in grado di garantire che i colori che appaiono in catalogo, né quelli personalizzati su richiesta, abbiano sempre lo stesso colore e aspetto.

BIC® MEDIA CLIC BALLPEN

BIC® MEDIA CLIC

1025 Penna a sfera / **ecolutions®** 1E25 Penna a sfera

BIC® MEDIA CLIC GRIP

1020 Penna a sfera / **ecolutions®** 1E20 Penna a sfera



Nessun costo aggiuntivo

MOQ 500 pz.

ecolutions® Combinazione colori standard

Tappino



Opaco



Frosted



Clip

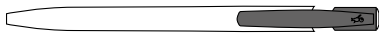

Opaco

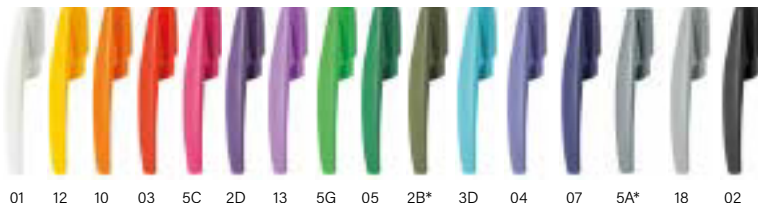

Frosted



Fusto



Opaco

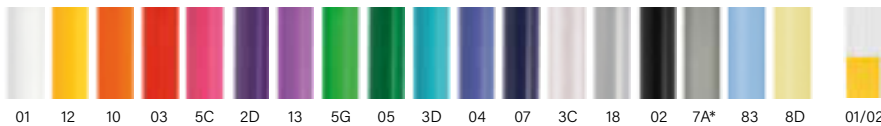

Corpo & Impugnatura

Frosted

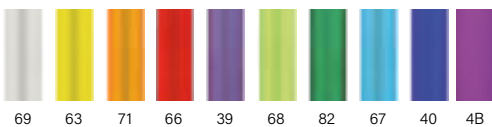

Corpo & Impugnatura

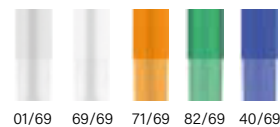

Lucido

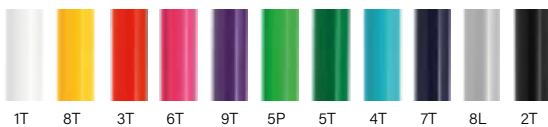

Clear

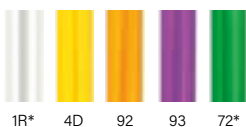

Combinazione colori standard***

Opaco

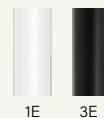

Corpo & Impugnatura Opaco

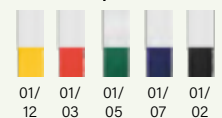

Aggiungi il Mobius loop alla tua grafica senza costi aggiuntivi. Si prega di specificarlo nell'ordine. La stampa del Mobius loop viene fatta di default nell'angolo a sinistra.

Esatta corrispondenza di colore: ≥ 10.000 pz. 1025/1E25

Esatta corrispondenza di colore: ≥ 20.000 pz. 1020/1E20



MARCATURA



COLORI PERSONALIZZATI



PRODOTTO E STAMPATO NEGLI STABILIMENTI BIC



PARTI IN PLASTICA PER AUTOVEICOLI



100% RICICLABILE

MODALITÀ DI SCRITTURA



PENNA A SFERA M

TECNICHE DI STAMPA



SERIGRAFIA



DIGITALE

BIC® MEDIA CLIC

1028 Portamine

BIC® MEDIA CLIC GRIP

1021 Portamine / eColutions® 1E21 Portamine



MOQ 500 pz.
Combinazione colori standard

Nessun costo aggiuntivo

Clip

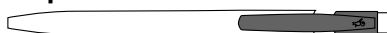

Opaco

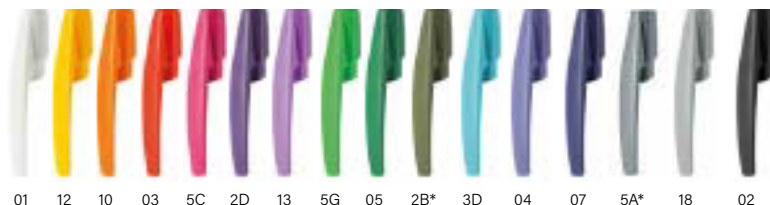

Frosted



01 12 10 03 5C 2D 13 5G 05 2B* 3D 04 07 5A* 18 02 69

Fusto



Opaco

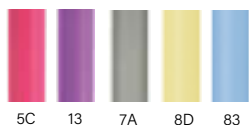

5C 13 7A 8D 83

Frosted

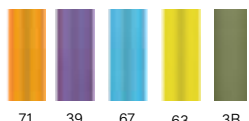

71 39 67 63 3B

Lucido



8T 3T 6T 9T 5P 5T

Corpo & Impugnatura



01/02

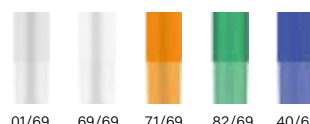

01/69 69/69 71/69 82/69 40/69



LA SOLUZIONE PER LA
COMUNICAZIONE FULL
COLOUR!

eColutions®



PARTI IN PLASTICA
PER AUTOVEICOLI

Combinazione colori
standard***

Corpo & Impugnatura

Opaco

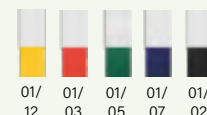

01/12 01/03 01/05 01/07 01/02



Aggiungi il Mobius loop alla tua grafica senza costi aggiuntivi. Si prega di specificarlo nell'ordine. La stampa del Mobius loop viene fatta di default nell'angolo a sinistra.

Tutta la gamma di colori disponibile in BritePix™ Digital

Esatta corrispondenza di colore: ≥ 10.000 pz. 1028

Esatta corrispondenza di colore: ≥ 20.000 pz. 1021 / 1E21



MARCATURA



COLORI
PERSONALIZZATI



PRODOTTO E
STAMPATO
NEGLI STABILIMENTI
BIC



PARTI IN
PLASTICA PER
AUTOVEICOLI



RICICLABILE

MODALITÀ DI SCRITTURA



PENNA A
SFERA M

TECNICHE DI STAMPA



SERIGRAFIA



DIGITALE

Vedere pagina 233 per una spiegazione dettagliata delle icone. *Fino ad esaurimento scorte

Servizio 48h non disponibile per stampa digitale *A causa del contenuto riciclato delle materie prime con cui è realizzato il prodotto, non siamo in grado di garantire che i colori che appaiono in catalogo, né quelli personalizzati su richiesta, abbiano sempre lo stesso colore e aspetto.

BIC® MEDIA CLIC

Personalizzazione

BIC® MEDIA CLIC

1025 Penna a sfera

1028 Portamine

ecolutions® 1E25 Penna a sfera

A SP: max. 4 col.

B SP: max. 2 col.

C DG: full-colour

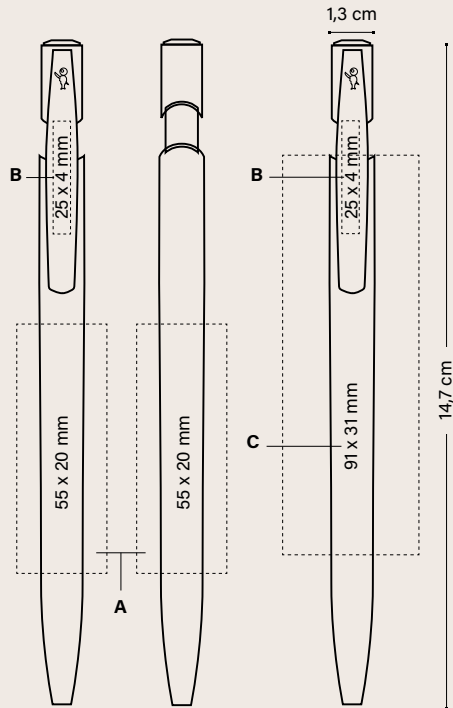

Prezzo (€)

BIC® MEDIA CLIC	500-999	1000-2499	2500-4999	5000
1025 / ecolutions® 1E25 (Penne)				
SP	0,65	0,58	0,54	0,50
DG	0,89	0,82	0,76	0,72
1028 (Portamine)				
SP	0,87	0,78	0,73	0,69
DG	1,03	0,94	0,87	0,83

Costo di stampa aggiuntivo per colore e posizione

SP	0,14	0,14	0,14	0,13
----	------	------	------	------

I prezzi includono una stampa in una posizione secondo la tecnica specificata.

CONFEZIONI SPECIALI OPZIONALI



ECO SLEEVE

PLASTIC POUCH

WINDOW BOX

+ INFO PAG. 222-227

IMBALLAGGIO ESTERNO



500 ± 4,1 KG

Personalizzazione

BIC® MEDIA CLIC GRIP

1020 Penna a sfera

1021 Portamine

D SP: max. 2 col.

E SP: max. 4 col.

F DG: full-colour

ecolutions® 1E20 Penna a sfera

ecolutions® 1E21 Portamine

D SP: max. 4 col.

E SP: max. 2 col.

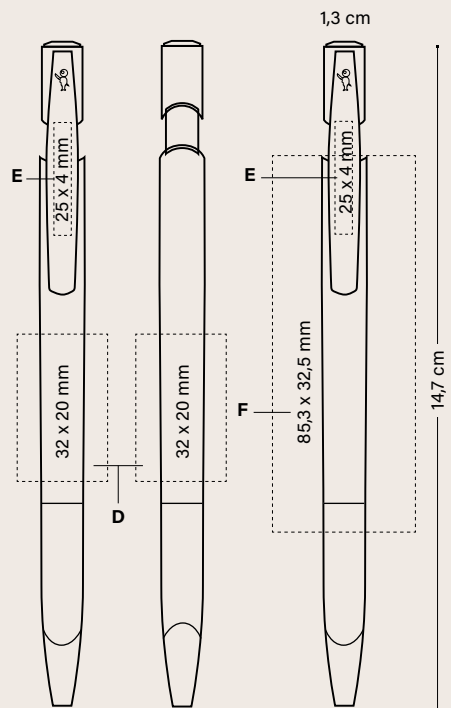

Prezzo (€)

BIC® MEDIA CLIC GRIP	500-999	1000-2499	2500-4999	5000
1020 / ecolutions® 1E20 (Penne)				
SP	0,90	0,84	0,79	0,73
DG	1,12	1,05	0,98	0,92

1021 / ecolutions® 1E21 (Portamine)

SP	1,03	0,96	0,90	0,84
DG	1,26	1,17	1,09	1,04

Costo di stampa aggiuntivo per colore e posizione

SP	0,14	0,14	0,14	0,13
----	------	------	------	------

I prezzi includono una stampa in una posizione secondo la tecnica specificata.

CONFEZIONI SPECIALI OPZIONALI



ECO SLEEVE

PLASTIC POUCH

WINDOW BOX

+ INFO PAG. 222-227

IMBALLAGGIO ESTERNO



500 ± 4,3 KG

MARCATURA



PRODOTTO E STAMPATO NEGLI STABILIMENTI BIC



FABRICADO EN ESPAÑA



PARTI IN PLASTICA PER AUTOVEICOLI



100% RICICLABILE



PENNA A SFERA M



SP SERIGRAFIA



DG DIGITALE

MODALITÀ DI SCRITTURA

TECNICHE DI STAMPA

BIC® MEDIA CLIC

Antibacterial

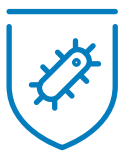

Protezione
batterica



Protezione della
superficie della
penna a sfera



Protezione
permanente



Test di protocollo
antibatterico



1E27

1026

BIC® MEDIA CLIC BGUARD™ ANTIBACTERIAL

BGUARD™



Protezione batterica



Protezione della superficie della penna a sfera



Protezione permanente



Test di protocollo antibatterico



LA SOLUZIONE PER LA COMUNICAZIONE FULL COLOUR!

BIC® MEDIA CLIC BGUARD™ ANTIBACTERIAL

1026: logo antibacterial

1027: logo SARS-CoV-2

Opaco

Colore inchiostro



Inchiostro rosso disponibile su richiesta



1BG

3BG

7BG

2BG



Iconico BIC® Boy e logo Antibacterial sempre visibili!



ANTIBACTERIAL™

MIX & MATCH

Nessun costo aggiuntivo

BIC® MEDIA CLIC BGUARD™ ANTIBACTERIAL

1026: logo antibacterial

1027: logo SARS-CoV-2

Opaco

MOQ 500 pz.

Combinazione colori standard

Tappino

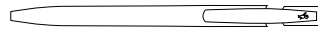

Opaco

1BG

3BG

7BG

2BG

Clip

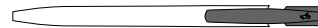

Opaco

1BG

3BG

07BG

2BG

Fusto



Opaco

1BG

3BG

7BG

2BG

Esatta corrispondenza di colore: ≥ 10.000 pz.



Personalizzazione:

BIC® MEDIA CLIC BGUARD™ ANTIBACTERIAL

1026: logo antibacterial
1027: logo SARS-CoV-2

A **SP**: max. 2 col.

B **SP**: max. 1 col.

C **DG**: full-colour

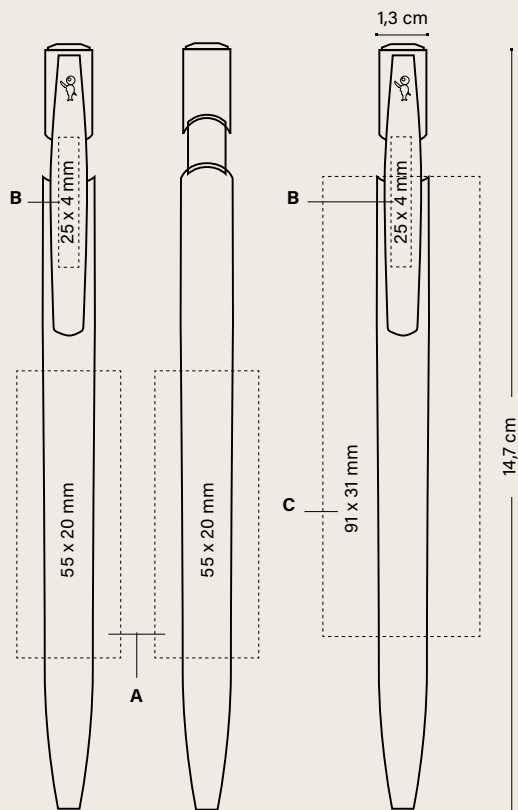

	Prezzo (€)			
BIC® MEDIA CLIC BGUARD™ ANTIBACTERIAL	500-999	1000-2499	2500-4999	5000
1026/1027				
SP	0,72	0,64	0,60	0,55
DG	0,95	0,88	0,82	0,77

Costo di stampa aggiuntivo per colore e posizione

SP	0,14	0,14	0,14	0,13
----	------	------	------	------

I prezzi includono una stampa in una posizione secondo la tecnica specificata.

CONFEZIONI SPECIALI OPZIONALI



ECO SLEEVE



PLASTIC POUCH



WINDOW BOX

+ INFO PAG. 222-227

IMBALLAGGIO ESTERNO



500 ± 4,1 KG

MARCATURA



COLORI
PERSONALIZZATI



PRODOTTO E STAMPATO
NEGLI STABILIMENTI BIC



PRODOTTO
IN SPAGNA



CONFORMITÀ
NORMATIVA



IMPRIM'VERT®



100%
RICICLABILE



100% ELETTRICITÀ
DA FONTI RINNOVABILI



BASSO IMPATTO
AMBIENTALE

MODALITÀ DI SCRITTURA



PENNA A SFERA M

TECNICHE DI STAMPA



SP
SERIGRAFIA



DG
DIGITALE

Vedere pagina 233 per una spiegazione dettagliata delle icone.

BIC® MEDIA CLIC BGUARD™ ANTIMICROBIAL ECOLUTIONS®

ANTIMICROBIAL™* =

 Protezione batterica 99% in 24h

+  93% di riduzione virale entro 24 ore

+  Inibizione di funghi 24 ore

BGUARD™ **ecolutions®**

MIX & MATCH

Nessun costo aggiuntivo

ecolutions®
REALIZZATA CON IL **86% DI MATERIALE RICICLATO****

PARTI IN PLASTICA PER AUTOVEICOLI



BIC® MEDIA CLIC BGUARD™ ANTIMICROBIAL ECOLUTIONS®

ecolutions® 1E26: logo antimicrobial

ecolutions® 1E27: logo SARS-CoV-2

Opaco

Colore inchiostro



Inchiostro rosso disponibile su richiesta



ecolutions®

PARTI IN PLASTICA PER AUTOVEICOLI



BIC® MEDIA CLIC BGUARD™ ANTIMICROBIAL ECOLUTIONS® ecolutions® 1E26 / ecolutions® 1E27



Aggiungi il Mobius loop alla tua grafica senza costi aggiuntivi. Si prega di specificarlo nell'ordine. La stampa del Mobius loop viene fatta di default nell'angolo a sinistra.

MOQ 500 pz.
Combinazione colori standard

Tappino

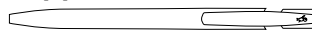

Opaco 1BG 3BG 7BG 2BG

Clip



Opaco 1BG 3BG 7BG 2BG

Fusto



Opaco 1E 3E

Esatta corrispondenza di colore: ≥ 10.000 pz.



Puoi anche scegliere di stampare il logo SARS-CoV-2 REDUCTION.
Per maggiori informazioni chiedi al tuo referente del servizio clienti.

*il 99,9% dei batteri è eliminato dalla superficie in 24 ore (e più del 30% in 2 ore)

Testato secondo il protocollo ISO 22196 adattato al reale uso della penna.

Il 93% dei virus, Sars-Cov-2 Coronavirus che causano la malattia da Covid-19, vengono eliminati dalla superficie in 24 ore (e circa il 50% in 2 ore).

Testato secondo il protocollo ISO 22196 adattato al reale uso della penna.

I funghi presenti sulla superficie vengono inibiti entro 24 ore.

Testato secondo il protocollo ISO 22196 adattato al reale uso della penna.



Protección de la superficie del Penna a esfera



Protezione permanente



Test di protocollo antibatterico



Conforme al Protocollo di test funghi



Protocollo test antivirale

Personalizzazione

BIC® MEDIA CLIC Bguard™ ANTIMICROBIAL ECOLUTIONS®

ecolutions® 1E26: logo antimicrobial

ecolutions® 1E27: logo SARS-CoV-2

A SP: max. 2 col.

B SP: max. 2 col.

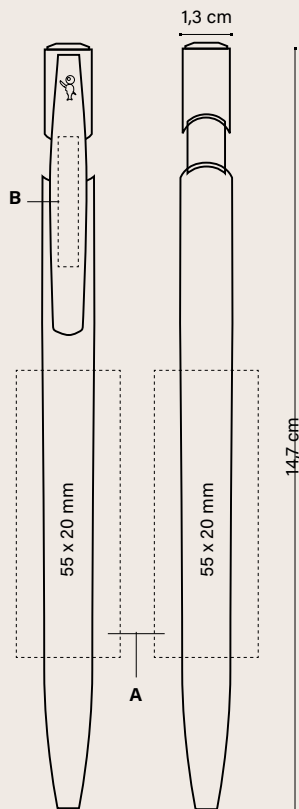

BIC® MEDIA CLIC Bguard™ ANTIMICROBIAL

500-999 1000-2499 2500-4999 5000

Prezzo (€)

ecolutions® 1E26 / ecolutions® 1E27

SP 0,78 0,71 0,67 0,59

Costo di stampa aggiuntivo per colore e posizione

SP 0,14 0,14 0,14 0,13

I prezzi includono serigrafia ad un colore in una posizione.

CONFEZIONI SPECIALI OPZIONALI



ECO SLEEVE



PLASTIC POUCH



WINDOW BOX

+ INFO PAG. 222-227

IMBALLAGGIO ESTERNO



500 ± 4,1 KG

MARCATURA



PRODOTTO E STAMPATO NEGLI STABILIMENTI BIC



PRODOTTO IN SPAGNA



CONFORMITÀ NORMATIVA



IMPRIM'VERT®

ecolutions®



PARTI IN PLASTICA PER AUTOVEICOLI



100% RICICLABILE



100% ELETTRICITÀ DA FONTI RINNOVABILI



BASSO IMPATTO AMBIENTALE

MODALITÀ DI SCRITTURA



PENNA A SFERA M

TECNICHE DI STAMPA



SP SERIGRAFIA

Vedere pagina 233 per una spiegazione dettagliata delle icone.

Disponibile in paesi selezionati, chiedere al rappresentante del servizio clienti

**La percentuale è calcolata sul peso totale del prodotto refill escluso. A causa del contenuto riciclato delle materie prime con cui è realizzato il prodotto, non siamo in grado di garantire che i colori che appaiono in catalogo, né quelli personalizzati su richiesta, abbiano sempre lo stesso colore e aspetto.

BIC® MEDIA CLIC
BIO-BASED ECOLUTIONS®

ecolutions®

BIO BASED

La sostenibilità è la sua priorità

Fatta per durare:

- Più di 10.000 clic!
- Maggiore visibilità al tuo marchio
- Clip infrangibile



PENNA DI ORIGINE BIOLOGICA

Hai finito l'inchiostro della penna?
Nessun problema, è compostabile*.

Fusto e **100% Bio-Based**.



100 % elettricità da fonti rinnovabili

L'energia per la produzione e la stampa
nelle nostre strutture deriva al **100%**
da fonti rinnovabili



BASSO IMPATTO DI TRASPORTO:
Produzione, stampa e anche materie
prime.



**100%
Riciclabile**
Ubicity™

**70%
Bio-Based
MATERIAL****

**100%
Bio-Based
COLORANTI**

BIC® MEDIA CLIC BIO-BASED ECOLUTIONS®



IL FUSTO È COMPOSTO AL 70%
DA MATERIALE BASE BIO**,
I COLORANTI SONO AL 100% BIO.



CANNA DA
ZUCCHERO



BIC® MEDIA CLIC BIO-BASED ECOLUTIONS®

1972 Penna a sfera

Opaco

Colore inchiostro



Inchiostro rosso disponibile su richiesta



12BIO

03BIO

04BIO

02BIO

05BIO

01BIO

Disponibile
in fusto bianco



MARCATURA



COLORI
PERSONALIZZATI



PRODOTTO E STAMPATO
NEGLI STABILIMENTI BIC



PRODOTTO
IN SPAGNA



CONFORMITÀ
NORMATIVA



IMPRIM'VERT®
ecolutions®



CANNA DA
ZUCCHERO



RICICLABILE



100 % ELETTRICITÀ
DA FONTI RINNOVABILI



BASSO IMPATTO
AMBIENTALE

MODALITÀ DI SCRITTURA



PENNA A SFERA M

TECNICHE DI STAMPA



SERIGRAFIA



DIGITALE

**La percentuale è calcolata sul peso totale del prodotto refill escluso, biodegradabile in condizioni industriali. A causa del contenuto naturale delle materie prime con cui è realizzato il prodotto, non siamo in grado di garantire che i colori che appaiono in catalogo, né quelli personalizzati su richiesta, abbiano sempre lo stesso colore e aspetto.

***Servizio 48h non disponibile per stampa digitale

BIC® MEDIA CLIC BIO-BASED ECOLUTIONS®



Nessun costo aggiuntivo

BIC® MEDIA CLIC BIO-BASED ECOLUTIONS®

1972 Penna a sfera Opaco

MOQ 500 pz.
Combinazione colori standard

Tappino



Clip

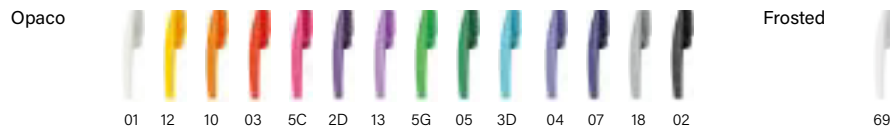

Fusto

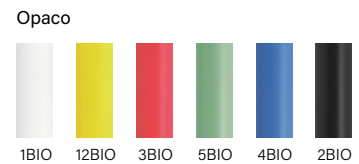

Esatta corrispondenza di colore:
≥ 10.000 pz.

MARCATURA



PRODOTTO E STAMPATO
NEGLI STABILIMENTI BIC



PRODOTTO IN SPAGNA



CANNA DA
ZUCCHERO



RICICLABILE

MODALITÀ DI SCRITTURA



PENNA A SFERA M

TECNICHE DI STAMPA



SERIGRAFIA



DIGITALE

Personalizzazione

BIC® MEDIA CLIC BIO-BASED ECOLUTIONS®

1972

A SP: max. 4 col.

B SP: max. 2 col.

C DG: full-colour

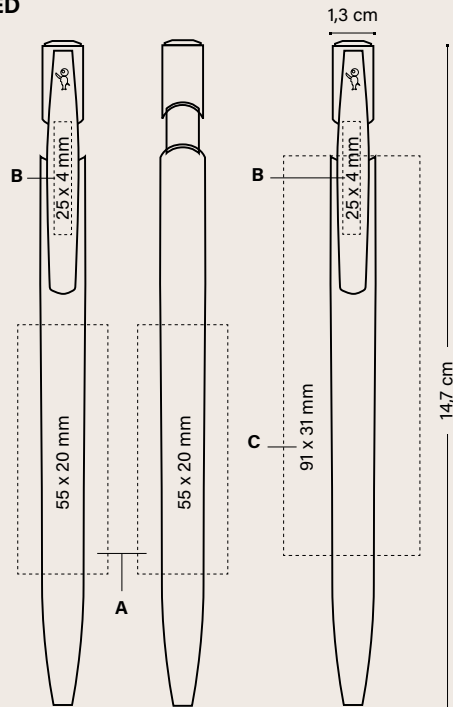

Prezzo (€)

BIC® MEDIA CLIC BIO-BASED	500-999	1000-2499	2500-4999	5000
---------------------------	---------	-----------	-----------	------

ecolutions® 1972

SP	0,78	0,72	0,67	0,62
DG	1,05	0,97	0,90	0,84

Costo di stampa aggiuntivo per colore e posizione

SP	0,14	0,14	0,14	0,13
----	------	------	------	------

I prezzi includono una stampa in una posizione secondo la tecnica specificata.

CONFEZIONI SPECIALI OPZIONALI



ECO
SLEEVE



PLASTIC
POUCH



WINDOW
BOX



IMBALLAGGIO ESTERNO

500 ± 4,3KG

+ INFO PAG. 222-227

**A causa del contenuto naturale delle materie prime con cui è realizzato il prodotto, non siamo in grado di garantire che i colori che appaiono in catalogo, né quelli personalizzati su richiesta, abbiano sempre lo stesso colore e aspetto.

BIC® MEDIA CLIC BIO-BASED BGuard™ ANTIBACTERIAL

BGuard™



Protezione batterica



Protezione della superficie della penna a sfera



Protezione permanente

ISO 22196

Test di protocollo antibatterico

BIO BASED



CANNA DA ZUCCHERO

IL FUSTO É COMPOSTO AL 70%
DA MATERIALE BASE BIO**,
I COLORANTI SONO AL 100% BIO.

BIC® MEDIA CLIC BIO-BASED BGuard™ ANTIBACTERIAL

1973 Penna a sfera

Opaco

Colore inchiostro



Inchiostro rosso disponibile su richiesta



04

02

05

01

Disponibile
in fusto bianco

britePix
DIGITAL

MARCATURA



MIX & MATCH



COLORI PERSONALIZZATI



PRODOTTO E STAMPATO NEGLI STABILIMENTI BIC



PRODOTTO IN SPAGNA



CONFORMITÀ NORMATIVA



ISO certified



IMPRIM'VERT*



CANNA DA ZUCCHERO



RICICLABILE



100 % ELETTRICITÀ DA FONTI RINNOVABILI



BASSO IMPATTO AMBIENTALE

MODALITÀ DI SCRITTURA



PENNA A SFERA M

TECNICHE DI STAMPA



SERIGRAFIA



DIGITALE

Vedere pagina 233 per una spiegazione dettagliata delle icone.

*Servizio 48h non disponibile per stampa

**La percentuale è calcolata sul peso totale del prodotto refill escluso, biodegradabile in condizioni industriali. A causa del contenuto naturale delle materie prime con cui è realizzato il prodotto, non siamo in grado di garantire che i colori che appaiono in catalogo, né quelli personalizzati su richiesta, abbiano sempre lo stesso colore e aspetto.

BIC® MEDIA CLIC BIO-BASED BGUARD™ ANTIBACTERIAL



Nessun costo aggiuntivo

BIC® MEDIA CLIC BIO-BASED BGUARD™ ANTIBACTERIAL

1973 Penna a sfera Opaco

MOQ 500 pz. Combinazione colori standard.

Tappino

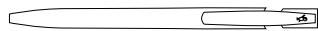

Opaco

01BG 03BG 07BG 02BG

Clip



Opaco

01BG 03BG 07BG 02BG

Fusto



Opaco

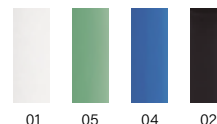

01 05 04 02

Esatta corrispondenza di colore: ≥ 10.000 pz.



MARCATURA



COLORI PERSONALIZZATI



PRODOTTO E STAMPATO NEGLI STABILIMENTI BIC



PRODOTTO IN SPAGNA



CANNDA DA ZUCCHERO



RICICLABILE

MODALITÀ DI SCRITTURA



PENNA A SFERA M

TECNICHE DI STAMPA



SERIGRAFIA



DIGITALE

Personalizzazione

BIC® MEDIA CLIC BIO-BASED BGUARD™ ANTIBACTERIAL

1973

A SP: max. 4 col.

B SP: max. 2 col.

C DG: full-colour

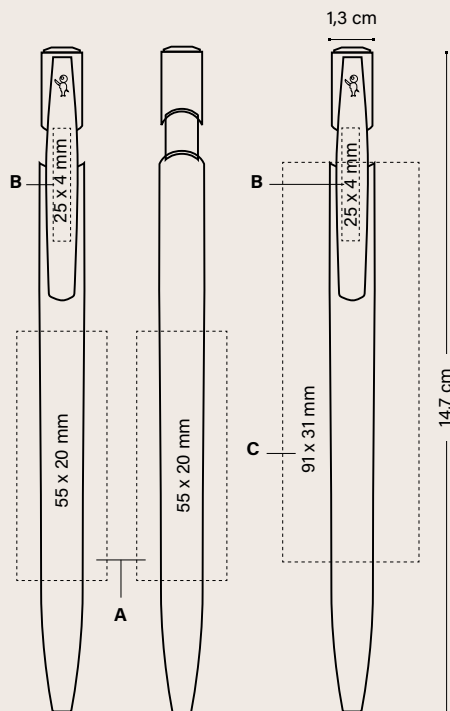

Prezzo (€)

BIC® MEDIA CLIC BIO-BASED BGUARD™ ANTIBACTERIAL	500-999	1000-2499	2500-4999	5000
---	---------	-----------	-----------	------

ecolutions® 1973

SP	0,86	0,81	0,73	0,68
DG	1,24	1,13	1,05	0,99

Costo di stampa aggiuntivo per colore e posizione

SP	0,14	0,14	0,14	0,13
----	------	------	------	------

I prezzi includono una stampa in una posizione secondo la tecnica specificata.

CONFEZIONI SPECIALI OPZIONALI



IMBALLAGGIO ESTERNO



250 ± 4,3 KG

+ INFO PAG. 222-227

*Servizio 48h non disponibile per stampa

**A causa del contenuto naturale delle materie prime con cui è realizzato il prodotto, non siamo in grado di garantire che i colori che appaiono in catalogo, né quelli personalizzati su richiesta, abbiano sempre lo stesso colore e aspetto.

BIC® MEDIA CLIC SHINE

BIC® MEDIA CLIC SHINE

1975 Penna a sfera Opaco

MOQ 500 pz. Combinazione colori standard.



Nessun costo aggiuntivo

Tappino

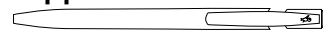

Opaco 01 12 10 03 5C 2D 13 84 5G 05 3D 04 07 18 02 Frosted 69

PREMIUM

35*

Clip



Opaco 01 12 10 03 5C 2D 13 2B* 5G 05 3D 04 07 18 02 Frosted 69

Fusto



Shine 26 47

BIC® MEDIA CLIC SHINE

1975 Penna a sfera

Opaco

Colore inchiostro



Inchiostro rosso disponibile su richiesta



47



100%

BIC® MEDIA CLIC SHINE

1975

A SP: max. 2 col.

B SP: max. 2 col.

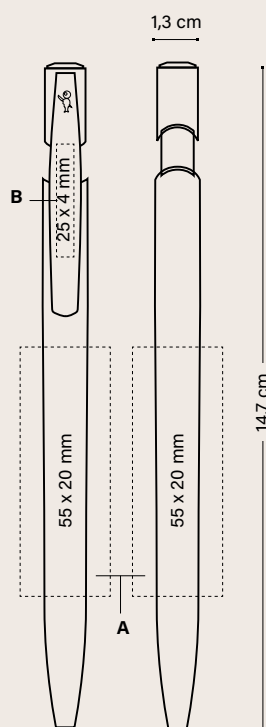

Prezzo (€)

BIC® MEDIA CLIC SHINE 500-999 1000-2499 2500-4999 5000

1975

SP 1,65 1,43 1,33 1,23

SP (premium) 1,80 1,57 1,46 1,35

Costo di stampa aggiuntivo per colore e posizione

SP 0,14 0,14 0,14 0,13

I prezzi includono serigrafia ad un colore in una posizione.

CONFEZIONI SPECIALI OPZIONALI



+ INFO PAG. 233 & 233

IMBALLAGGIO ESTERNO



500 ± 4,1 KG

MARCATURA



COLORI PERSONALIZZATI



PRODOTTO E STAMPATO NEGLI STABILIMENTI BIC



PRODOTTO IN SPAGNA



CONFORMITÀ NORMATIVA



IMPRIM'VERT®



100% RICICLABILE



100% ELETTRICITÀ DA FONTI RINNOVABILI



BASSO IMPATTO AMBIENTALE

MODALITÀ DI SCRITTURA



PENNA A SFERA M

TECNICHE DI STAMPA



SERIGRAFIA

Vedere pagina 233 per una spiegazione dettagliata delle icone.

*Fino ad esaurimento scorte

BIC® MEDIA CLIC GLACÉ

Colori eleganti del nostro best seller

BIC® MEDIA CLIC GLACÉ

1030 Opaco

Colore inchiostro



Inchiostro rosso disponibile su richiesta



47G



76



03G



05G



04G



14G

BIC® MEDIA CLIC GLACÉ

1030 Penna a sfera Opaco

MOQ 500 pz.
Combinazione colori standard

Tappino

Opaco 01 12 10 03 5C 2D 13 84 5G 05 3D 04 07 18 02 Frosted 69

Clip

Opaco 01 12 10 03 5C 2D 13 2B* 5G 05 3D 04 07 5A 18 02 Frosted 69

Fusto

Opaco 47G 76 03G 14G 05G 04G

Personalizzazione

BIC® MEDIA CLIC GLACÉ

1030

A SP: max. 2 col.

B SP: max. 2 col.

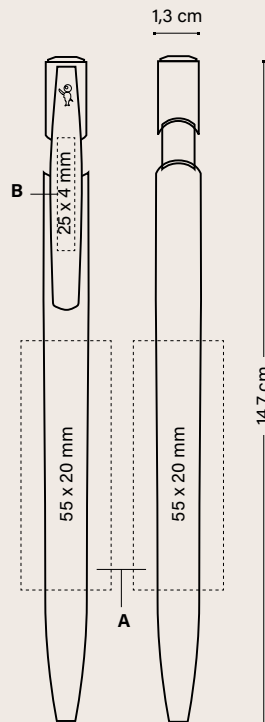

	Prezzo (€)			
BIC® MEDIA CLIC GLACÉ	500-999	1000-2499	2500-4999	5000
1030				
SP	1,19	1,02	0,97	0,88

Costo di stampa aggiuntivo per colore e posizione

SP	0,14	0,14	0,14	0,13
-----------	------	------	------	------

I prezzi includono serigrafia ad un colore in una posizione.

CONFEZIONI SPECIALI OPZIONALI



ECO SLEEVE



PLASTIC POUCH



WINDOW BOX



500 ± 4,1 KG

IMBALLAGGIO ESTERNO

MARCATURA



PRODOTTO E STAMPATO NEGLI STABILIMENTI BIC



PRODOTTO IN SPAGNA



CONFORMITÀ NORMATIVA



IMPRIM'VERT®



100% RICCICLABILE



100% ELETTRICITÀ DA FONTI RINNOVABILI



BASSO IMPATTO AMBIENTALE

MODALITÀ DI SCRITTURA



PENNA A SFERA M

TECNICHE DI STAMPA



SP SERIGRAFIA

Vedere pagina 233 per una spiegazione dettagliata delle icone.

BIC® CLIC STIC

**Moderna, flessibile,
affidabile. Ecco com'è
BIC® Clic Stic !**

Una grande varietà
di finiture come
Digital, Stylus,
Softfeel®, Mini o
Antibatterica

*Migliaia di
combinazioni
di colori!*





L'iconico BIC® Boy è inciso!

BIC® CLIC STIC

1000 Opaco

Colore inchiostro



Disponibile
in fusto bianco



Versione ECO.

Allo stesso prezzo della versione standard!

ecolutions®

VASSOI DI FRUTTA
E VERDURA



REALIZZATA CON IL 78%
DI MATERIALE RICICLATO***

BIC® CLIC STIC

1E00 Opaco

Colore inchiostro



Disponibile
in fusto bianco



MARCATURA



MIX & MATCH



COLORI
PERSONALIZZATI



PRODOTTO E STAMPATO
NEGLI STABILIMENTI BIC



PRODOTTO IN SPAGNA



CONFORMITÀ
NORMATIVA



IMPRIM'VERT®



VASSOI DI
FRUTTA E
VERDURA



RICICLABILE



100 % ELETTRICITÀ
DA FONTI RINNOVABILI



BASSO IMPATTO
AMBIENTALE

MODALITÀ DI SCRITTURA



PENNA A SFERA M

TECNICHE DI STAMPA



SERIGRAFIA



DIGITALE

*Fino ad esaurimento scorte

**Servizio 48h non disponibile per stampa

***La percentuale è calcolata sul peso totale del prodotto refill escluso. A causa del contenuto riciclato delle materie prime con cui è realizzato il prodotto, non siamo in grado di garantire che i colori che appaiono in catalogo, né quelli personalizzati su richiesta, abbiano sempre lo stesso colore e aspetto.

*Versione ECO.
Allo stesso prezzo della
versione standard!*

ecolutions®
 REALIZZATA CON
**IL 78% DE MATERIAL
 RICICLATO****

 VASSOI DI FRUTTA
 E VERDURA

BIC® CLIC STIC

1000 Frosted

Colore inchiostro

● ● ●

Inchiostro rosso disponibile su richiesta



*Clip
infrangibile!*



BIC® CLIC STIC

1E00 Frosted

Colore inchiostro

● ● ●

*Inchiostro rosso disponibile
su richiesta*



BIC® CLIC STIC

SOFTFEEL®

1005 Opaco

Colore inchiostro

● ● ●

*Inchiostro rosso
disponibile su richiesta*



BIC® CLIC STIC SOFTFEEL®
 1005 Frosted
 Colore inchiostro
 ● ● ●
 Inchiostro rosso disponibile su richiesta



40

BIC® CLIC STIC STYLUS
 1847 Opaco
 Colore inchiostro
 ● ● ●
 Inchiostro rosso disponibile su richiesta



01

03

04

18

02

07

BIC® CLIC STIC STYLUS
 1846 Opaco
 Colore inchiostro
 ● ● ●
 Inchiostro rosso disponibile su richiesta



1E

3E

Versione ECO.
 Allo stesso prezzo della versione standard!

ecolutions®
 REALIZZATA CON IL 78% DE MATERIAL RICICLADO**

VASSOI DI FRUTTA E VERDURA

MARCATURA



MIX & MATCH



COLORI PERSONALIZZATI



PRODOTTO E STAMPATO NEGLI STABILIMENTI BIC



PRODOTTO IN SPAGNA



CONFORMITÀ NORMATIVA



IMPRIM'VERT®

ecolutions®



VASSOI DI FRUTTA E VERDURA



100% RICICLABILE



100% ELETTRICITÀ DA FONTI RINNOVABILI



BASSO IMPATTO AMBIENTALE

MODALITÀ DI SCRITTURA



PENNA A SFERA M

TECNICHE DI STAMPA



SP SERIGRAFIA



DG DIGITALE

*Servizio 48h non disponibile per stampa digitale

**La percentuale è calcolata sul peso totale del prodotto refill escluso. A causa del contenuto riciclato delle materie prime con cui è realizzato il prodotto, non siamo in grado di garantire che i colori che appaiono in catalogo, né quelli personalizzati su richiesta, abbiano sempre lo stesso colore e aspetto.

MARCATURA



MIX & MATCH



COLORI PERSONALIZZATI



PRODOTTO E STAMPATO NEGLI STABILIMENTI BIC



PRODOTTO IN SPAGNA



CONFORMITÀ NORMATIVA



IMPRIM'VERT®



VASSOI DI FRUTTA E VERDURA



RICICLABILE



100 % ELETTRICITÀ DA FONTI RINNOVABILI



BASSO IMPATTO AMBIENTALE

MODALITÀ DI SCRITTURA



PENNA A SFERA M

TECNICHE DI STAMPA



SERIGRAFIA



DIGITALE

BIC® CLIC STIC MINI

1892 Opaco

Colore inchiostro



Inchiostro rosso disponibile su richiesta

BIC® CLIC STIC MINI

1892 Frosted

Colore inchiostro



Inchiostro rosso disponibile su richiesta



Stampa a 360°

Disponibile in fusto bianco



BIC® CLIC STIC

1000 Opaco / **ecolutions®** 1E00 Opaco
 1000 Frosted / **ecolutions®** 1E00 Frosted
 1005 Opaco / Frosted
 MOQ 500 pz. Combinazione colori standard

BIC® CLIC STIC STYLUS

1846 / 1847 Opaco

BIC® CLIC STIC MINI

1892 Opaco / Frosted

**MIX &
MATCH**

Nessun costo aggiuntivo

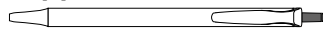
Tappino

Opaco

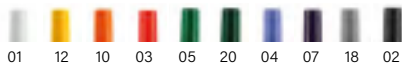

Frosted

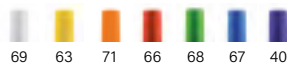
**Clip**

Opaco

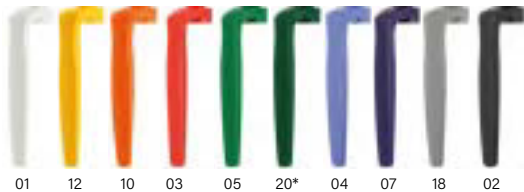

Frosted

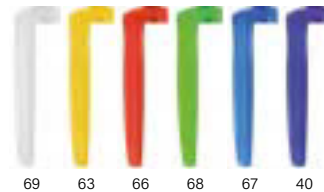
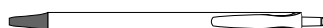
**Sezione**

Opaco

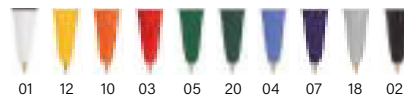

Frosted

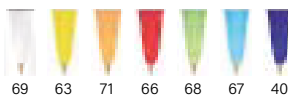
**Stylus**

Opaco

**Fusto**

Opaco

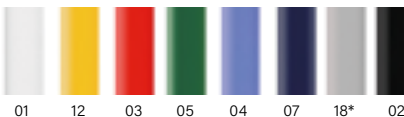
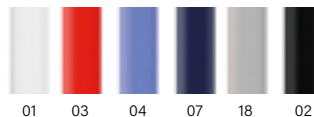
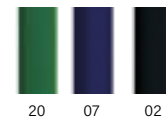
**Stylus****Softfeel®****Mini**

Frosted

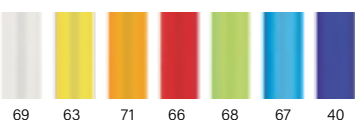

Esatta corrispondenza di colore: ≥ 10.000 pz.

ecolutions®

MOQ 500 pz.

ecolutions® Combinazione colori standard**



Aggiungi il Mobius loop alla tua grafica senza costi aggiuntivi. Si prega di specificarlo nell'ordine. La stampa del Mobius loop viene fatta di default nell'angolo a sinistra.

VASSOI DI FRUTTA
E VERDURA

**Tappino**

Opaco

**Sezione**

Opaco

**Clip**

Opaco

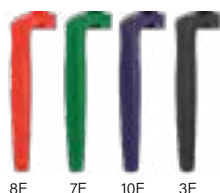
**Fusto**

Opaco

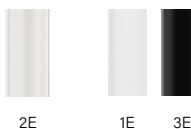

Frosted

**Stylus**

Esatta corrispondenza di colore: ≥ 10.000 pz.

*Fino ad esaurimento scorte

**A causa del contenuto riciclato delle materie prime con cui è realizzato il prodotto, non siamo in grado di garantire che i colori che appaiono in catalogo, né quelli personalizzati su richiesta, abbiano sempre lo stesso colore e aspetto.

ESPECIFICACIONES



COLORI
PERSONALIZZATI



PRODOTTO E STAMPATO
NEGLI STABILIMENTI BIC



PRODOTTO IN SPAGNA



CONFORMITÀ
NORMATIVA



VASSOI DI
FRUTTA E
VERDURA



RICICLABILE



100% ELETTRICITÀ
DA FONTI RINNOVABILI



BASSO IMPATTO
AMBIENTALE

MODALITÀ DI SCRITTURA



PENNA A SFERA M

TECNICHE DI STAMPA



SERIGRAFIA



DIGITALE

Personalizzazione

BIC® CLIC STIC

1000 / **ecolutions®** 1E00

BIC® CLIC STIC STYLUS

1847 / **ecolutions®** 1846

A SP: max. 3 col.

B SP: max. 1 col.

C SP: max. 2 col.

D DG: full-colour (area per il testo)
(Disponibile solo in fusto bianco)

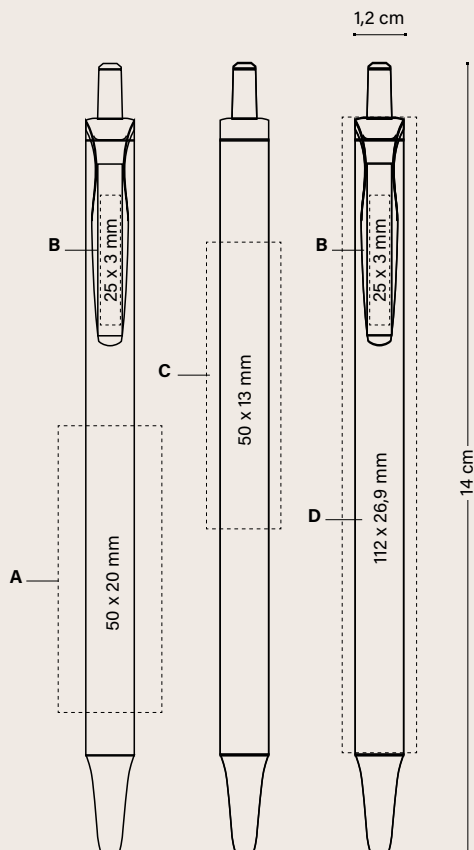

	500-999	1000-2499	2500-4999	Prezzo (€)
BIC® CLIC STIC				
1000 / ecolutions® 1E00				
SP	0,85	0,74	0,70	0,66
DG	1,14	1,02	0,96	0,90
1847 / ecolutions® 1846				
SP	1,02	0,91	0,85	0,77
DG	1,31	1,15	1,08	1,02

Costo di stampa aggiuntivo per colore e posizione

SP	0,14	0,14	0,14	0,13
----	------	------	------	------

I prezzi includono una stampa in una posizione secondo la tecnica specificata.

CONFEZIONI SPECIALI OPZIONALI



ECO
SLEEVE



PLASTIC
POUCH

+ INFO PAG. 222-227

IMBALLAGGIO ESTERNO



500 ± 2,9 KG

Personalizzazione

BIC® CLIC STIC SOFTFEEL®
1005

A/B SP: max. 1 col.

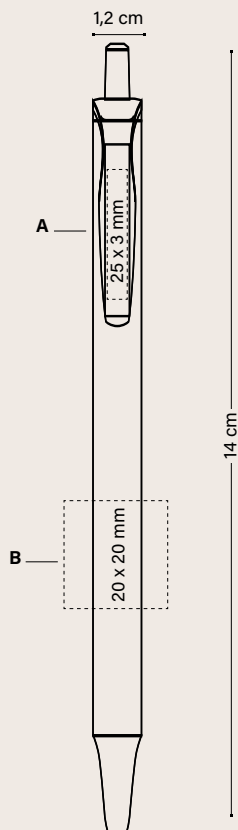

Prezzo (€)

BIC® CLIC STIC SOFTFEEL®	500-999	1000-2499	2500-4999	5000
1005				
SP	1,05	0,94	0,88	0,80

Costo di stampa aggiuntivo per colore e posizione

SP	0,14	0,14	0,14	0,13
----	------	------	------	------

I prezzi includono serigrafia ad un colore in una posizione.

CONFEZIONI SPECIALI OPZIONALI



+ INFO PAG. 222-227

IMBALLAGGIO ESTERNO



500 ± 2,9 KG

Personalizzazione

BIC® CLIC STIC MINI
1892

A SP: max. 1 col.

B SP: max. 1 col.

C DG: full-colour (area per il testo)
(Disponibile solo in fusto bianco)

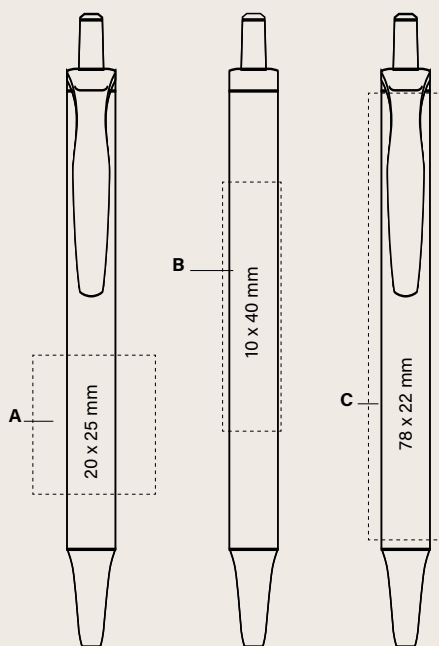

Prezzo (€)

BIC® CLIC STIC MINI	500-999	1000-2499	2500-4999	5000
1892				
SP	0,71	0,64	0,60	0,57
DG	1,06	0,95	0,88	0,82

I prezzi includono una stampa in una posizione secondo la tecnica specificata.

CONFEZIONI SPECIALI OPZIONALI



+ INFO PAG. 222-227

IMBALLAGGIO ESTERNO



500 ± 2,4 KG

MARCATURA



COLORI PERSONALIZZATI



PRODOTTO E STAMPATO NEGLI STABILIMENTI BIC



PRODOTTO IN SPAGNA



CONFORMITÀ NORMATIVA



ISO certified

IMPRIM'VERT®



100% RICICLABILE



100% ELETTRICITÀ DA FONTI RINNOVABILI



BASSO IMPATTO AMBIENTALE

MODALITÀ DI SCRITTURA



PENNA A SFERA M

TECNICHE DI STAMPA



SERIGRAFIA



DIGITALE

Vedere pagina 233 per una spiegazione dettagliata delle icone.

BIC® CLIC STIC BGUARD™ ANTIBACTERIAL

BGUARD™



Protezione batterica



Protezione della superficie della penna a sfera



Protezione permanente



Test di protocollo antibatterico



Iconico BIC® Boy e logo Antibacterial sempre visibili!

ANTIBACTERIAL™

BIC® CLIC STIC BGUARD™ ANTIBACTERIAL

1001 Opaco

Colore inchiostro



Inchiostro rosso disponibile su richiesta



7BG



2BG



3BG



Stampa a 360°

100%

Disponibile in fusto bianco



MIX & MATCH

Nessun costo aggiuntivo

BIC® CLIC STIC BGUARD™ ANTIBACTERIAL

1001 Opaco

MOQ 500 pz.

Combinazione colori standard

Tappino

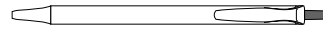

Opaco



Clip

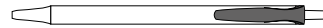

Opaco



Sezione



Opaco

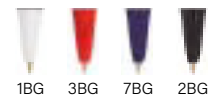

Fusto



Opaco

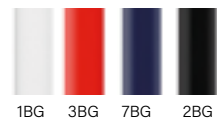

Esatta corrispondenza di colore: ≥ 10.000 pz.



Personalizzazione

BIC® CLIC STIC BGUARD™ ANTIBACTERIAL

1001

A SP: max. 2 col.

B SP: max. 1 col.

C DG: full-colour

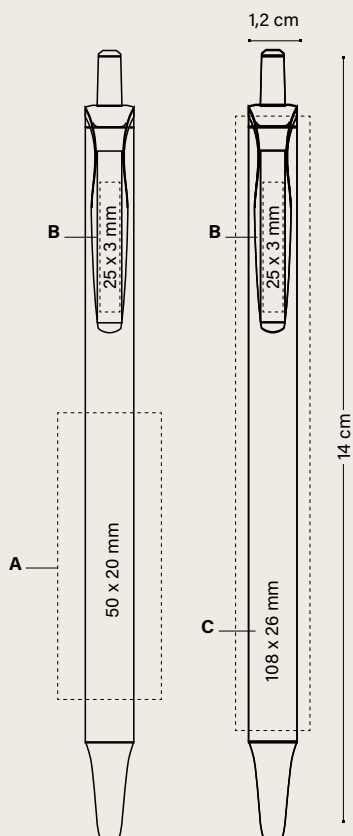

	Prezzo (€)			
BIC® CLIC STIC BGUARD™ ANTIBACTERIAL	500-999	1000-2499	2500-4999	5000
1001				
SP	0,87	0,77	0,72	0,68
DG	1,16	1,03	0,96	0,91

Costo di stampa aggiuntivo per colore e posizione

SP	0,14	0,14	0,14	0,13
-----------	------	------	------	------

I prezzi includono una stampa in una posizione secondo la tecnica specificata.

CONFEZIONI SPECIALI OPZIONALI



+ INFO PAG. 222-227



IMBALLAGGIO ESTERNO



MARCATURA



COLORI
PERSONALIZZATI



PRODOTTO E STAMPATO
NEGLI STABILIMENTI BIC



PRODOTTO IN SPAGNA



CONFORMITÀ
NORMATIVA



IMPRIM'VERT®



100%
RICICLABILE



100% ELETTRICITÀ
DA FONTI RINNOVABILI



BASSO IMPATTO
AMBIENTALE

MODALITÀ DI SCRITTURA



PENNA A SFERA M

TECNICHE DI STAMPA



SERIGRAFIA



DIGITALE

Vedere pagina 233 per una spiegazione dettagliata delle icone.

BIC® CLIC STIC STYLUS BGUARD™ ANTIBACTERIAL

BGUARD™



Protezione batterica



Protezione della superficie della penna a sfera



Protezione permanente



Test di protocollo antibatterico



Iconico BIC® Boy e logo Antibacterial sempre visibili!

ANTIBACTERIAL™

BIC® CLIC STIC STYLUS BGUARD™ ANTIBACTERIAL

1848 Opaco

Colore inchiostro



Inchiostro rosso disponibile su richiesta

Prima penna antibatterica Stylus!

MIX & MATCH

Nessun costo aggiuntivo



3BG

7BG

2BG

100%
1BG

Disponibile in fusto bianco



Stampa a 360°

BIC® CLIC STIC STYLUS BGUARD™ ANTIBACTERIAL

1848 Opaco

MOQ 500 pz.

Combinazione colori standard

Tappino



Opaco



Clip

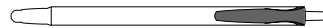

Opaco



Sezione



Stylus

Opaco



02

Fusto



Opaco

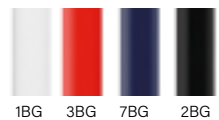

Esatta corrispondenza di colore: ≥ 10.000 pz.



Personalizzazione

BIC® CLIC STIC STYLUS BGUARD™ ANTIBACTERIAL

1848

A SP: max. 2 col.

B SP: max. 1 col.

C DG: full-colour

(Disponibile solo in fusto bianco)

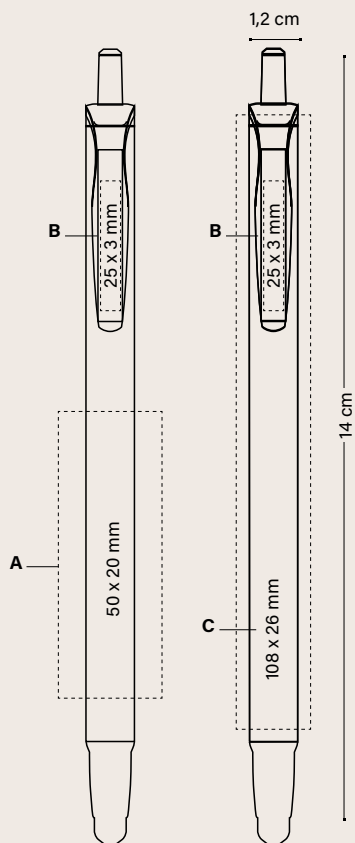

BIC® CLIC STIC STYLUS BGUARD™ ANTIBACTERIAL 1848	Prezzo (€)			
	500-999	1000-2499	2500-4999	5000
SP	1,13	1,00	0,95	0,88
DG	1,44	1,27	1,19	1,12

Costo di stampa aggiuntivo per colore e posizione

SP	0,14	0,14	0,14	0,13
----	------	------	------	------

I prezzi includono una stampa in una posizione secondo la tecnica specificata.

CONFEZIONI SPECIALI OPZIONALI



ECO
SLEEVE



PLASTIC
POUCH

+ INFO PAG. 222-227

IMBALLAGGIO ESTERNO



500 ± 2,9 KG

MARCATURA

MIX &
MATCH



COLORI
PERSONALIZZATI



PRODOTTO E STAMPATO
NEGLI STABILIMENTI BIC



PRODOTTO IN SPAGNA



CONFORMITÀ
NORMATIVA



IMPRIM'VERT®



100%
RICICLABILE



100 % ELETTRICITÀ
DA FONTI RINNOVABILI



BASSO IMPATTO
AMBIENTALE

MODALITÀ
DI SCRITTURA



PENNA A SFERA M

TECNICHE
DI STAMPA



SP
SERIGRAFIA



DG
DIGITALE

Vedere pagina 233 per una spiegazione dettagliata delle icone.



BIC® SUPER CLIP

Scopri l'accattivante clip e il suo fluido meccanismo twist. La grande area di stampa XXL offre un'ampia gamma di possibilità di personalizzazione nelle versioni standard, advance e antibatterica. Ora disponibile anche nelle versioni soft e glacé.

Inoltre, la BIC® Super Clip Origin è la prima penna a sfera di una nuova fase più innovativa e sostenibile. Benvenuti nel futuro!

Ecolutions®

BGuard™ Antibacterial

Advance

Glacé

Glacé Advance

Soft

Soft Advance

Origin

BIC® SUPER CLIP

BIC® SUPER CLIP

1039 Opaco

Colore inchiostro



Area di stampa
XXL!



Disponibile
in fusto bianco



Versione ECO.
Allo stesso prezzo della versione standard!

ecolutions®



REALIZZATA CON IL 78%
DI MATERIALE RICICLATO***



PARTI IN PLASTICA
PER AUTOVEICOLI

BIC® SUPER CLIP

1E50 Opaco

Colore inchiostro



1E

BIC® SUPER CLIP

1039 Clear

Colore inchiostro



51

87

86

89

88

MARCATURA



COLORI
PERSONALIZZATI



PRODOTTO E STAMPATO
NEGLI STABILIMENTI BIC



PRODOTTO IN SPAGNA



CONFORMITÀ
NORMATIVA



IMPRIM'VERT®
ecolutions®



PARTI IN PLASTICA
PER AUTOVEICOLI



RICICLABILE



100% ELETTRICITÀ
DA FONTI RINNOVABILI



BASSO IMPATTO
AMBIENTALE

**MODALITÀ
DI SCRITTURA**



PENNA A SFERA M

**TECNICHE
DI STAMPA**



SERIGRAFIA



DIGITALE



BRITEPIX™
BRITEPIX™ TEXTURE
BRITEPIX™
PERSONALISATION

**Servizio 48h non disponibile per stampa

***La percentuale è calcolata sul peso totale del prodotto refill escluso. A causa del contenuto riciclato delle materie prime con cui è realizzato il prodotto, non siamo in grado di garantire che i colori che appaiono in catalogo, né quelli personalizzati su richiesta, abbiano sempre lo stesso colore e aspetto.

BIC® SUPER CLIP

BIC® SUPER CLIP

1039 Opaco

ecolutions® 1E50 Opaco

1039 Clear

MOQ 250 pz.

Combinazione colori standard



Nessun costo aggiuntivo

Clip



Opaco

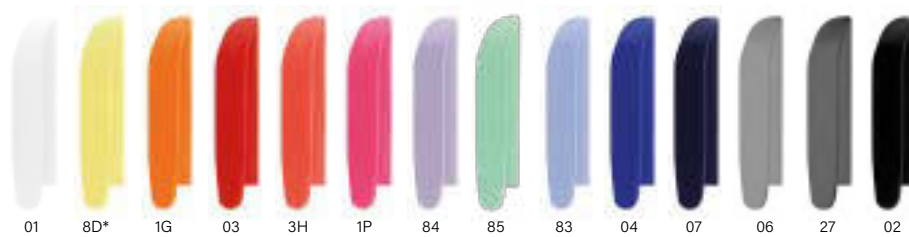

Clear



ecolutions®



PARTI IN PLASTICA
PER AUTOVEICOLI

Combinazione
colori standard**



1E 1E



Aggiungi il Mobius loop alla tua grafica senza costi aggiuntivi. Si prega di specificarlo nell'ordine. La stampa del Mobius loop viene fatta di default nell'angolo a sinistra.

Fusto



Opaco

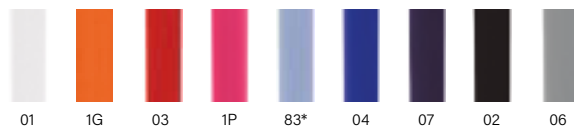

Clear

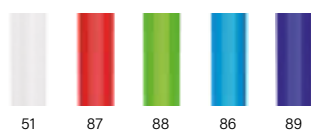

Esatta corrispondenza di colore: ≥ 10.000 pz.



*Fino ad esaurimento scorte
**A causa del contenuto riciclato delle materie prime con cui è realizzato il prodotto, non siamo in grado di garantire che i colori che appaiono in catalogo, né quelli personalizzati su richiesta, abbiano sempre lo stesso colore e aspetto.

Personalizzazione

BIC® SUPER CLIP

1039

ecolutions® 1E50

A SP: max. 2 col.

B SP: max. 1 col.

1039

C DG: full-colour

D BP: full-colour

BP Texture: full-colour

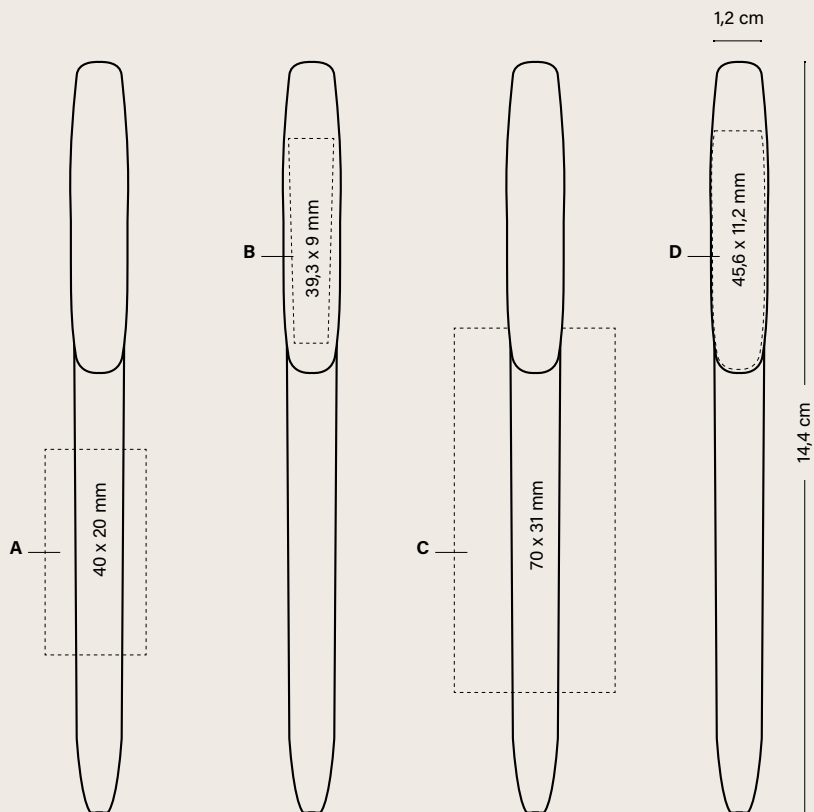

BIC® SUPER CLIP 1039 / ecolutions® 1E50	Prezzo (€)				
	250-499	500-999	1000-2499	2500-4999	5000
SP	1,08	0,97	0,92	0,88	0,86
DG	1,40	1,26	1,20	1,16	1,14
BP	1,34	1,22	1,16	1,12	1,09

Costo di stampa aggiuntivo per colore e posizione

SP	0,17	0,14	0,14	0,14	0,13
BP	0,24	0,22	0,21	0,20	0,19
BP Texture	0,18	0,16	0,15	0,15	0,14

I prezzi includono una stampa in una posizione secondo la tecnica specificata.

CONFEZIONI SPECIALI OPZIONALI



+ INFO PAG. 222-227



PLASTIC POUCH



WINDOW BOX

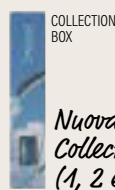

COLLECTION BOX

Nuova!
Collection Box
(1, 2 e 3 pz.)



250 ± 2,6 KG

IMBALLAGGIO ESTERNO

MARCATURA



COLORI PERSONALIZZATI



PRODOTTO E STAMPATO NEGLI STABILIMENTI BIC



PRODOTTO IN SPAGNA



CONFORMITÀ NORMATIVA



ISO certified

IMPRIM'VERT®

ecolutions®



PARTI IN PLASTICA PER AUTOVEICOLI



100% RICICLABILE



100% ELETTRICITÀ DA FONTI RINNOVABILI



BASSO IMPATTO AMBIENTALE

MODALITÀ DI SCRITTURA



PENNA A SFERA M

TECNICHE DI STAMPA



SP SERIGRAFIA



DG DIGITALE



BP BRITEPIX™
BRITEPIX™ TEXTURE
BRITEPIX™ PERSONALISATION

Vedere pagina 233 per una spiegazione dettagliata delle icone.

BIC® SUPER CLIP BGUARD™ ANTIBACTERIAL

BGUARD™



Protezione batterica



Protezione della superficie della penna a sfera



Protezione permanente



Test di protocollo antibatterico

MIX & MATCH

Nessun costo aggiuntivo

BIC® SUPER CLIP BGUARD™ ANTIBACTERIAL

1040 Opaco

Colore inchiostro



BIC® SUPER CLIP BGUARD™ ANTIBACTERIAL

1040 Opaco

MOQ 250 pz.

Combinazione colori standard

Clip



Opaco



1BG 3BG 7BG 2BG

Fusto



Opaco



1BG 3BG 7BG 2BG

Esatta corrispondenza di colore: > 10.000 pz.



ANTIBACTERIAL™

Logo Antibacterial sempre visibile!

Personalizzazione

BIC® SUPER CLIP BGUARD™ ANTIBACTERIAL

1040

A/B SP: max. 1 col.

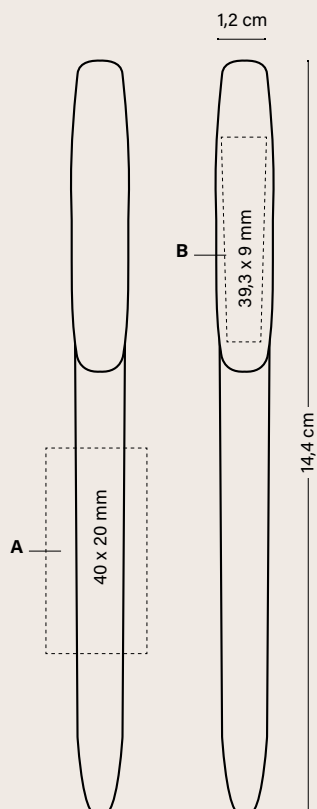

	Prezzo (€)				
BIC® SUPER CLIP BGUARD™ ANTIBACTERIAL	250-499	500-999	1000-2499	2500-4999	5000

1040					
SP	1,23	1,10	1,06	1,03	1,00

Costo di stampa aggiuntivo per colore e posizione

SP	0,17	0,14	0,14	0,14	0,13
-----------	------	------	------	------	------

I prezzi includono serigrafia ad un colore in una posizione.

CONFEZIONI SPECIALI OPZIONALI



ECO
SLEEVE



PLASTIC
POUCH



WINDOW
BOX

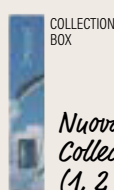

COLLECTION
BOX

*Nuova!
Collection Box
(1, 2 e 3 pz.)*



250 ± 2,6 KG

+ INFO PAG. 222-227

IMBALLAGGIO ESTERNO

MARCATURA



MIX &
MATCH



COLORI
PERSONALIZZATI



PRODOTTO E STAMPATO
NEGLI STABILIMENTI BIC



PRODOTTO IN SPAGNA



CONFORMITÀ
NORMATIVA



ISO
certified



100%
RICICLABILE



100% ELETTRICITÀ
DA FONTI RINNOVABILI



BASSO IMPATTO
AMBIENTALE

MODALITÀ
DI SCRITTURA



PENNA A SFERA M

TECNICHE
DI STAMPA



SP
SERIGRAFIA

Vedere pagina 233 per una spiegazione dettagliata delle icone.

BIC® SUPER CLIP ADVANCE

1073 Opaco

Colore inchiostro



*Scegli tra le 3 finiture
a sezione in metallo!*

Sezione in metallo!



35

26

97

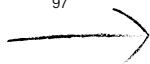

03



1G



04



07

*Servizio
di
ricarica
su
richiesta*



Disponibile
in fusto bianco



MARCATURA



COLORI
PERSONALIZZATI



PRODOTTO E STAMPATO
NEGLI STABILIMENTI BIC



PRODOTTO IN SPAGNA



CONFORMITÀ
NORMATIVA



IMPRIM'VERT®



100%
RICICLABILE



100% ELETTRICITÀ
DA FONTI RINNOVABILI



BASSO IMPATTO
AMBIENTALE

MODALITÀ
DI SCRITTURA



PENNA A SFERA M

TECNICHE
DI STAMPA



SP
SERIGRAFIA



DG
DIGITALE



BP
BRITEPIX™
BRITEPIX™ TEXTURE
BRITEPIX™
PERSONALISATION

Vedere pagina 233 per una spiegazione dettagliata delle icone.

BIC® SUPER CLIP ADVANCE

BIC® SUPER CLIP ADVANCE

1073 Opaco

MOQ 250 pz.
Combinazione colori standard

**MIX &
MATCH**

Nessun costo aggiuntivo

Clip

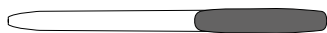

Opaco



01 1G 03 1P 04 07 06 02

Clear



51 87 93 88 86 89

Fusto



Opaco



01 1G 03 1P 04 07 06 02

Sezione

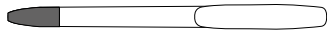

35 26 97

Esatta corrispondenza di colore: ≥ 10.000 pz.



Personalizzazione

BIC® SUPER CLIP ADVANCE

1073

A SP: max. 2 col.

B SP: max. 1 col.

C DG: full-colour

D BP: full-colour

BP Texture: full-colour

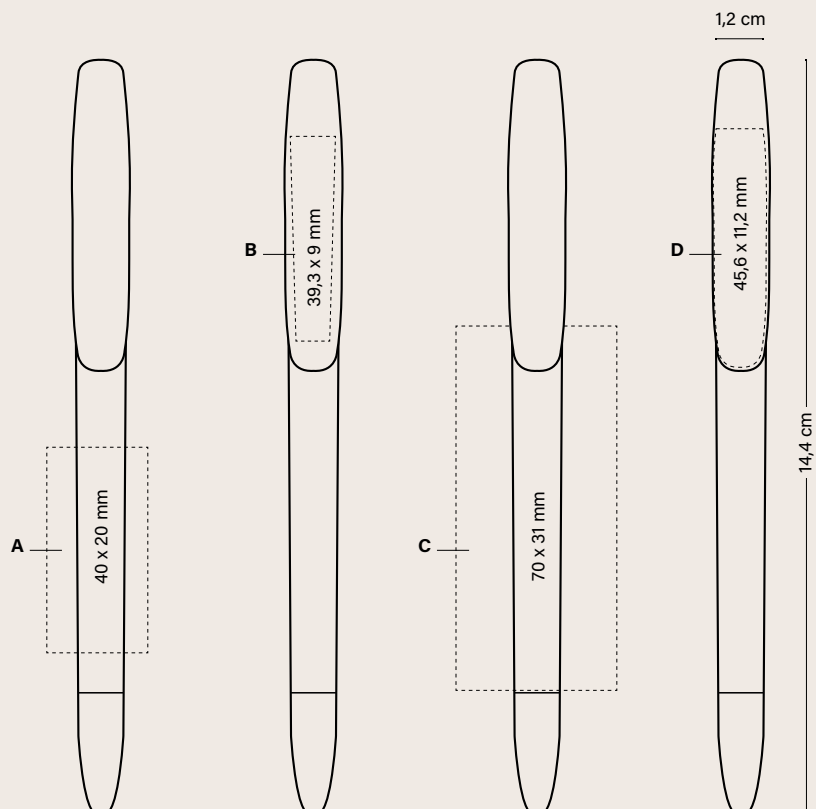

Prezzo (€)

BIC® SUPER CLIP ADVANCE	250-499	500-999	1000-2499	2500-4999	5000
1073					
SP	1,55	1,35	1,29	1,26	1,21
DG	1,90	1,63	1,56	1,51	1,47
BP	1,78	1,54	1,48	1,43	1,39

Costo di stampa aggiuntivo per colore e posizione

SP	0,17	0,14	0,14	0,14	0,13
BP	0,24	0,22	0,21	0,20	0,19
BP Texture	0,18	0,16	0,15	0,15	0,14
Sezione Oro / Rosa	0,15	0,15	0,15	0,15	0,15

I prezzi includono una stampa in una posizione secondo la tecnica specificata.

CONFEZIONI SPECIALI OPZIONALI



+ INFO PAG. 222-227



PLASTIC POUCH



WINDOW BOX

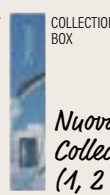

Nuova!
Collection Box
(1, 2 e 3 pz.)



250 ± 2,6 KG

IMBALLAGGIO ESTERNO

MARCATURA



MIX & MATCH



COLORI PERSONALIZZATI



PRODOTTO E STAMPATO NEGLI STABILIMENTI BIC



PRODOTTO IN SPAGNA



CONFORMITÀ NORMATIVA



ISO certified



100% RICICLABILE



100% ELETTRICITÀ DA FONTI RINNOVABILI



BASSO IMPATTO AMBIENTALE

MODALITÀ DI SCRITTURA



PENNA A SFERA M

TECNICHE DI STAMPA



SERIGRAFIA



DIGITALE



BRITEPIX™
BRITEPIX™ TEXTURE
BRITEPIX™ PERSONALISATION

Vedere pagina 233 per una spiegazione dettagliata delle icone.

NUOVO!

BIC® SUPER CLIP GLACÉ & ADVANCE

Scopri la BIC® Super Clip nella sua nuova versione più glamour.

BIC® SUPER CLIP GLACÉ

1082

Colore inchiostro



47G

76

014G

03G

04G

05G

BIC® SUPER CLIP GLACÉ ADVANCE

1084

Colore inchiostro



47G/35

05G/35

014G/35

03G/35

04G/35

76/35

Servizio di ricarica su richiesta

Disponibile in 3 finiture: argento, oro e rosa



35

26

97

BIC® SUPER CLIP GLACÉ & ADVANCE

Sezione

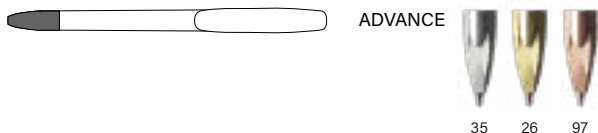

Personalizzazione

BIC® SUPER CLIP GLACÉ
1082

**BIC® SUPER CLIP GLACÉ
ADVANCE**
1084

A SP: max. 2 col.
B SP: max. 1 col.

MOQ 250 pz.
Combinazione colori standard

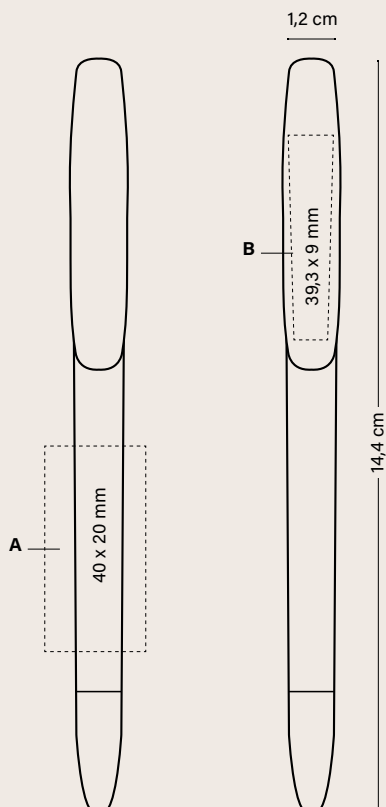

BIC® SUPER CLIP GLACÉ	Prezzo (€)				
	250-499	500-999	1000-2499	2500-4999	5000
1082					
SP	1,80	1,58	1,47	1,42	1,37
1084					
SP	2,10	1,81	1,70	1,65	1,60

Costo di stampa aggiuntivo per colore e posizione

SP	0,17	0,14	0,14	0,14	0,13
Sezione Oro / Rosa	0,15	0,15	0,15	0,15	0,15

I prezzi includono una stampa in una posizione secondo la tecnica specificata.

CONFEZIONI SPECIALI OPZIONALI



+ INFO PAG. 222-227

IMBALLAGGIO ESTERNO



*Nuova!
Collection Box
(1, 2 e 3 pz.)*

MARCATURA



COLORI
PERSONALIZZATI



PRODOTTO E STAMPATO
NEGLI STABILIMENTI BIC



PRODOTTO IN EUROPA



CONFORMITÀ
NORMATIVA



IMPRIM'VERT®



100%
RICICLABILE



100% ELETTRICITÀ
DA FONTI RINNOVABILI



BASSO IMPATTO
AMBIENTALE

MODALITÀ DI SCRITTURA



PENNA A SFERA M

TECNICHE DI STAMPA



SERIGRAFIA



GUARDA IL VIDEO

Vedere pagina 233 per una spiegazione dettagliata delle icone.

NUOVO!

BIC® SUPER CLIP SOFT & ADVANCE

Apprezza l'incredibile sensazione di setosità della nostra nuova BIC® Super Clip con meccanismo twist.



BIC® SUPER CLIP SOFT

1083

Colore inchiostro



02F

03F

07F

BIC® SUPER CLIP SOFT ADVANCE

1085

Colore inchiostro



02F/35

03F/35

07F/35

Servizio di ricarica su richiesta

Disponibile in 3 finiture: argento, oro e rosa



35

26

97

BIC® SUPER CLIP SOFT & ADVANCE

Sezione

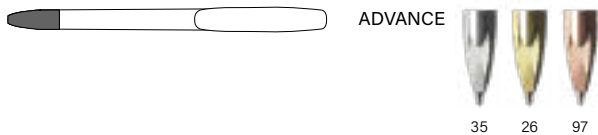

Personalizzazione

BIC® SUPER CLIP SOFT
1083

**BIC® SUPER CLIP SOFT
ADVANCE**
1085

A SP: max. 1 col.

MOQ 250 pz.
Combinazione colori standard

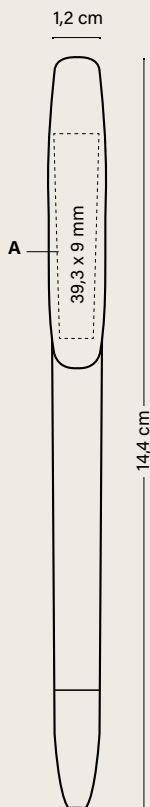

	Prezzo (€)				
	250-499	500-999	1000-2499	2500-4999	5000
BIC® SUPER CLIP SOFT					
1083					
SP	2,22	1,94	1,83	1,75	1,71
BIC® SUPER CLIP SOFT ADVANCE					
1085					
SP	2,51	2,19	2,06	1,98	1,94

Costo di stampa aggiuntivo per colore e posizione

SP	0,17	0,14	0,14	0,14	0,13
Sezione Oro / Rosa	0,15	0,15	0,15	0,15	0,15

I prezzi includono una stampa in una posizione secondo la tecnica specificata.

CONFEZIONI SPECIALI OPZIONAL



+ INFO PAG. 222-227

IMBALLAGGIO ESTERNO



250 ± 2,6 KG

*Nuova!
Collection Box
(1, 2 e 3 pz.)*

MARCATURA



PRODOTTO E STAMPATO
NEGLI STABILIMENTI BIC



PRODOTTO IN EUROPA



CONFORMITÀ
NORMATIVA



IMPRIM'VERT®



RICICLABILE



100 % ELETTRICITÀ
DA FONTI RINNOVABILI



BASSO IMPATTO
AMBIENTALE

MODALITÀ DI SCRITTURA



PENNA A SFERA M

TECNICHE DI STAMPA



SERIGRAFIA



GUARDA IL VIDEO

Vedere pagina 233 per una spiegazione dettagliata delle icone.

NUOVO!

BIC® SUPER CLIP ORIGIN

La nostra nuova BIC® Super Clip è realizzata a partire da materiali naturali.

ecolutions®

REALIZZATA CON MATERIALE
DI ORIGINE BIOLOGICA**

BIC® SUPER CLIP ORIGIN

1038

Colore inchiostro



ORIGIN ^{BIO}_{BASED}

BIC® Super Clip Origin è realizzata a partire da materiali naturali, composto da polimeri naturali che escludono petrolio, olio ed energia fossile*.



Olio di ricino di
origine biologica



Segatura di legno

Dalle foreste europee gestite in modo
sostenibile



Talco

Estratto in Europa

Meccanismo
twist fluido!

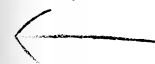

Prodotto e stampato in
stabilimenti alimentati al **100%**
da energia elettrica rinnovabile.



Fusto e clip di origine
biologica al **100%**.



Grazie al programma **UBICUITY™**,
gli strumenti di scrittura BIC®
sono riciclabili al **100%**.



Prodotto in Europa,
a basso impatto di
trasporto.



BIC® SUPER CLIP ORIGIN

Personalizzazione

BIC® SUPER CLIP ORIGIN

1038

A SP: max. 1 col.

MOQ 250 pz.
Combinazione colori standard

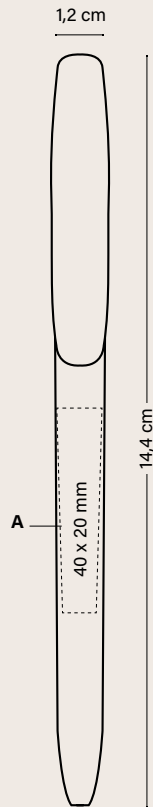

Prezzo (€)

BIC® SUPER CLIP ORIGIN	250-499	500-999	1000-2499	2500-4999	5000
1038					
SP	1,93	1,84	1,76	1,68	1,64

I prezzi includono serigrafia ad un colore in una posizione.

CONFEZIONI SPECIALI OPZIONALI



ECO SLEEVE



PLASTIC POUCH



WINDOW BOX



COLLECTION BOX

Nuova!
Collection Box
(1, 2 e 3 pz.)



250 ± 2,6 KG

+ INFO PAG. 222-227

IMBALLAGGIO ESTERNO

MARCATURA



COLORI PERSONALIZZATI



PRODOTTO E STAMPATO NEGLI STABILIMENTI BIC



PRODOTTO IN EUROPA



CONFORMITÀ NORMATIVA



ISO certified



IMPRIM'VERT®

ORIGIN

BIO BASED



ACEITE DE RICINO DE ORIGIN BIOLÓGICO



SERRÍN DE MADERA



TALCO



100% RICICLABILE



100% ELETTRICITÀ DA FONTI RINNOVABILI



BASSO IMPATTO AMBIENTALE

TECNICHE DI STAMPA



SERIGRAFIA

BIC® WIDE BODY™

**La giusta misura
per mostrare
il vero valore
del tuo marchio!**

**Ampio profilo e vasta
gamma di possibilità per
ottimizzare il tuo messaggio.**





L'iconico BIC® Boy è inciso!

BIC® WIDE BODY™

1079 Opaco Chrome

1080 Opaco

Colore inchiostro



Inchiostro rosso disponibile su richiesta



07

01

07

02

18



100%

Stampa a 360°

Disponibile in fusto bianco



BIC® WIDE BODY™

eColutions® 1E80 Opaco

Colore inchiostro



Inchiostro rosso disponibile su richiesta



100%

Stampa a 360°

Disponibile in fusto bianco



Versione ECO.
Allo stesso prezzo della versione standard!

eColutions®



REALIZZATA CON IL 94% DI MATERIALE RICICLATO**



VASSOI DI FRUTTA E VERDURA

MARCATURA



MIX & MATCH



COLORI PERSONALIZZATI



PRODOTTO E STAMPATO NEGLI STABILIMENTI BIC



PRODOTTO IN SPAGNA



CONFORMITÀ NORMATIVA



IMPRIM'VERT®

eColutions®



VASSOI DI FRUTTA E VERDURA



RICICLABILE



100% ELETTRICITÀ DA FONTI RINNOVABILI



BASSO IMPATTO AMBIENTALE

MODALITÀ DI SCRITTURA



PENNA A SFERA M

TECNICHE DI STAMPA



SERIGRAFIA



DIGITALE

*Servizio 48h non disponibile per stampa

**La percentuale è calcolata sul peso totale del prodotto refill escluso. A causa del contenuto riciclato delle materie prime con cui è realizzato il prodotto, non siamo in grado di garantire che i colori che appaiono in catalogo, né quelli personalizzati su richiesta, abbiano sempre lo stesso colore e aspetto.

BIC® WIDE BODY™

1080 Frosted

Colore inchiostro



40

63

67

68

69

66

71

100%

*La vostra
area di
stampa più
grande*

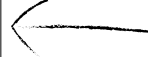

BIC® WIDE BODY™

MINI DIGITAL

1893 Opaco

1896 Chrome Opaco

Colore inchiostro



01

01

100%

*Stampa a
360°*

*Disponibile
in fusto bianco*



BIC® WIDE BODY™

1080 Opaco
eColutions® 1E80 Opaco
1080 Frosted

BIC® WIDE BODY™ MINI DIGITAL

1893 Opaco
1896 Chrome Opaco

MOQ 250 pz.
Combinazione colori standard

**MIX &
MATCH**

Nessun costo aggiuntivo

Tappino



Opaco

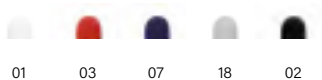

Frosted

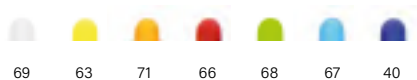

Chrome



Clip



Opaco

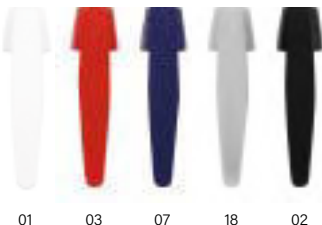

Frosted

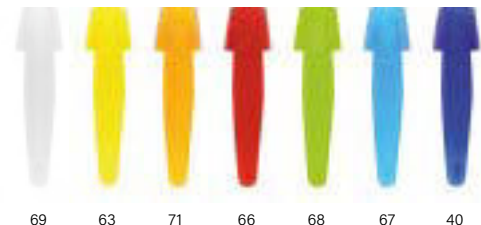

Fusto



Opaco



Frosted

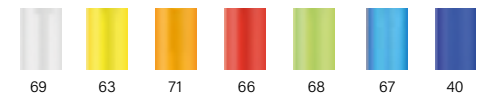

MARCATURA



**MIX &
MATCH**



COLORI
PERSONALIZZATI



PRODOTTO E STAMPATO
NEGLI STABILIMENTI BIC



PRODOTTO IN SPAGNA



CONFORMITÀ
NORMATIVA



IMPRIM'VERT®

eColutions®



VASSOI DI
FRUTTA
E VERDURA



RICICLABILE



100 % ELETTRICITÀ
DA FONTI RINNOVABILI



BASSO IMPATTO
AMBIENTALE

MODALITÀ
DI SCRITTURA



PENNA A SFERA M

TECNICHE
DI STAMPA



SERIGRAFIA



DIGITALE

Opaco



eColutions® ***



Aggiungi il Mobius loop alla tua grafica senza costi aggiuntivi. Si prega di specificarlo nell'ordine. La stampa del Mobius loop viene fatta di default nell'angolo a sinistra.



VASSOI DI
FRUTTA
E VERDURA

Sezione



Opaco



Frosted

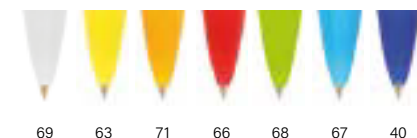

Chrome



Esatta corrispondenza di colore: ≥ 10.000 pz.



*Fino ad esaurimento scorte

**Servizio 48h non disponibile per stampa digitale

*** A causa del contenuto riciclato delle materie prime con cui è realizzato il prodotto, non siamo in grado di garantire che i colori che appaiono in catalogo, né quelli personalizzati su richiesta, abbiano sempre lo stesso colore e aspetto.

BIC® WIDE BODY™

BIC® WIDE BODY™

1080 Opaco
1079 Opaco Chrome
eColutions® 1E80

A/C SP: max. 2 col.
B/F SP: max. 1 col.
D DG: full-colour (area per le immagini)
E DG: full-colour (area per il testo)

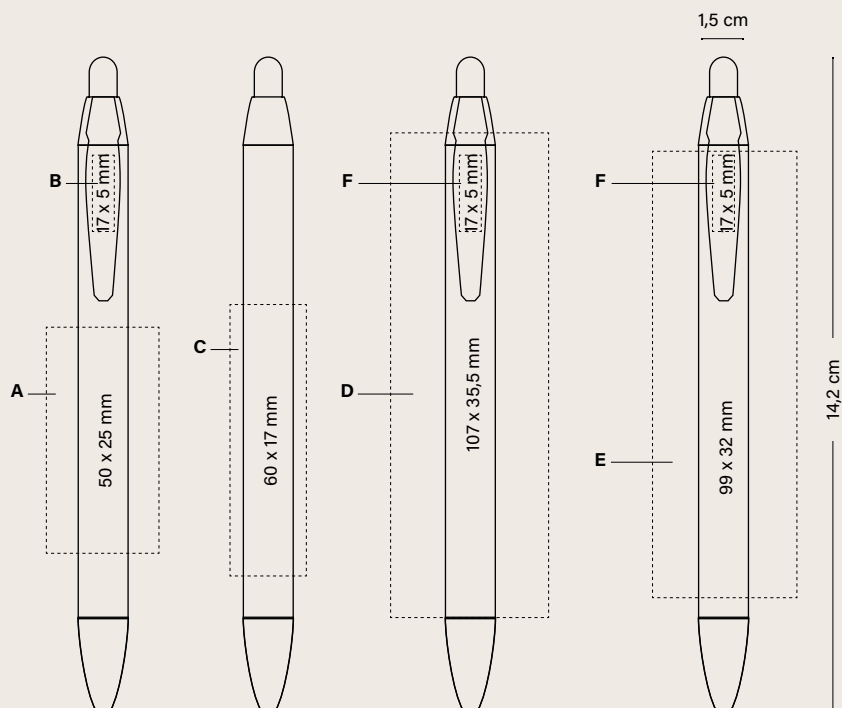

	Prezzo (€)				
BIC® WIDE BODY™	250-499	500-999	1000-2499	2500-4999	5000
1080 / eColutions® 1E80					
SP	1,25	1,02	0,96	0,90	0,82
DG	-	1,42	1,32	1,23	1,15
1079					
SP	2,39	1,94	1,79	1,70	1,56
DG	-	2,32	2,16	2,05	1,91

Costo di stampa aggiuntivo per colore e posizione

SP	0,17	0,14	0,14	0,14	0,13
----	------	------	------	------	------

I prezzi includono una stampa in una posizione secondo la tecnica specificata.

CONFEZIONI SPECIALI OPZIONAL

IMBALLAGGIO ESTERNO

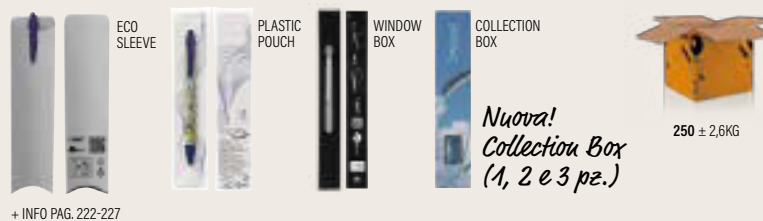

+ INFO PAG. 222-227

**BIC® WIDE BODY™
MINI DIGITAL**

1893

**BIC® WIDE BODY™
MINI CHROME DIGITAL**

1896

A DG: full-colour (area per le immagini)

B DG: full-colour (area per il testo)

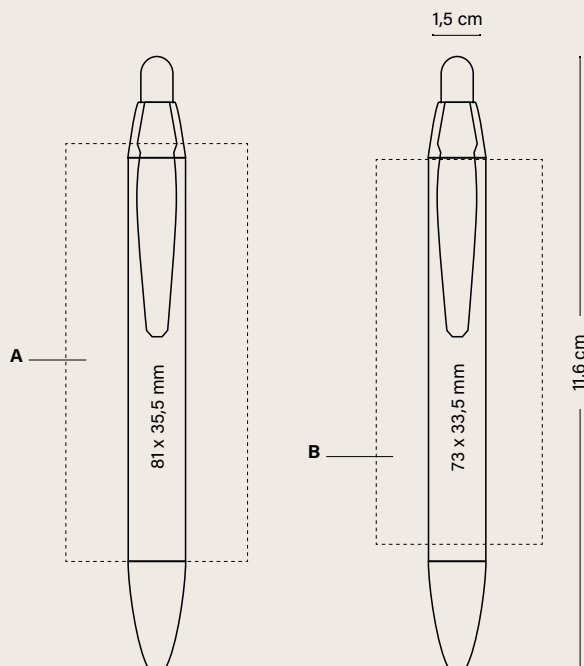

	Prezzo (€)			
	500-999	1000-2499	2500-4999	5000
1893				
DG	1,25	1,16	1,09	1,03
1896				
DG	2,16	2,02	1,92	1,76

I prezzi includono stampa digitale sul corpo.

CONFEZIONI SPECIALI OPZIONAL



ECO SLEEVE



PLASTIC POUCH



WINDOW BOX

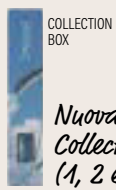

COLLECTION BOX

*Nuova!
Collection Box
(1, 2 e 3 pz.)*



250 ± 2,6KG

+ INFO PAG. 222-227

IMBALLAGGIO ESTERNO

MARCATURA



COLORI PERSONALIZZATI



PRODOTTO E STAMPATO NEGLI STABILIMENTI BIC



PRODOTTO IN SPAGNA



CONFORMITÀ NORMATIVA



VASSOI DI FRUTTA E VERDURA



RICICLABILE



100 % ELETTRICITÀ DA FONTI RINNOVABILI



BASSO IMPATTO AMBIENTALE

MODALITÀ DI SCRITTURA



PENNA A SFERA M

TECNICHE DI STAMPA



SERIGRAFIA



DIGITALE

Vedere pagina 233 per una spiegazione dettagliata delle icone.

BIC® WIDE BODY™ BGUARD™ ANTIBACTERIAL

BGUARD™



Protezione batterica



Protezione della superficie della penna a sfera



Protezione permanente

ISO 22196

Test di protocollo antibatterico

 **ANTIBACTERIAL™**

Logo Antibacterial sempre visibile!

**WIDE BODY™ BGUARD™
ANTIBACTERIAL**

1081 Opaco

Colore inchiostro



Inchiostro rosso disponibile su richiesta



1BG



2BG



3BG



7BG

100%



1BG

Stampa a 360°

*Disponibile
in fusto bianco*



MOQ 250 pz.

Tappino



Opaco

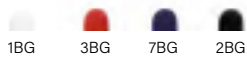

Fusto



Opaco

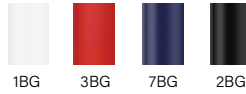

Clip

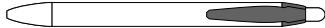

Opaco

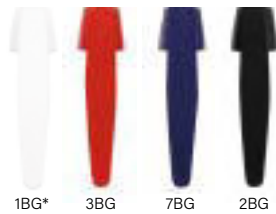

Sezione

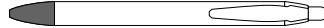

Opaco

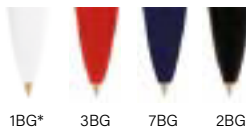

Esatta corrispondenza di colore: ≥ 10.000 pz.

**BIC® WIDE BODY™
BGUARD™
ANTIBACTERIAL**
1081

A/C SP: max. 1 col.
B/F SP: max. 1 col.
D DG: full-colour (area per le immagini)
E DG: full-colour (area per il testo)

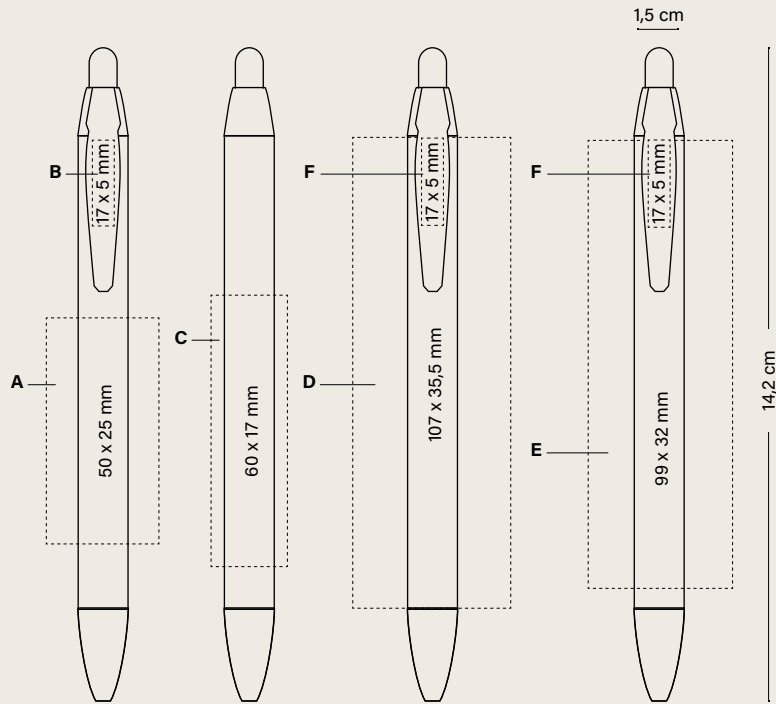

Prezzo (€)

BIC® WIDE BODY™ BGUARD™ ANTIBACTERIAL 1081	250-499	500-999	1000-2499	2500-4999	5000
SP	1,31	1,07	1,01	0,94	0,87
DG	-	1,49	1,38	1,29	1,22

Costo di stampa aggiuntivo per colore e posizione

SP	0,17	0,14	0,14	0,14	0,13
----	------	------	------	------	------

I prezzi includono una stampa in una posizione secondo la tecnica specificata.

CONFEZIONI SPECIALI OPZIONAL



**Nuova!
Collection Box
(1, 2 e 3 pz.)**



250 ± 2,6KG

+ INFO PAG. 222-227

MARCATURA



MODALITÀ DI SCRITTURA



TECNICHE DI STAMPA



Vedere pagina 233 per una spiegazione dettagliata delle icone.



BIC® 4 COLOURS®

Conosciuta in tutto il mondo, la penna a sfera BIC® 4 Colours® ti offre la comodità di quattro diversi colori di inchiostro in un'unica penna, rendendola un'ottima scelta per prendere appunti o registrare dati in diversi colori. Questa penna versatile ha una punta media di 1,0 mm e contiene inchiostro a lunga durata. Per una maggiore comodità, è dotata di un foro per un laccetto, così da portarla con te ovunque. Scopri tutte le diverse versioni: Classic, Fashion, Sun, Fine, Shine, Fluo, Stylus, 3+1^{HB} (con portamine) Glacé e le ultime versioni Soft e Wood Style.

Soft

Wood Style

Sun

Fashion

Shine

Glacé

Fine

Fluo

3+1^{HB}



LA SOLUZIONE PER
LA COMUNICAZIONE
FULL COLOUR!

*Ora sui nuovi
corpi colorati*

BIC® 4 COLOURS®

1100 Opaco

1101 Con Lanyard

Colore inchiostro



01/01

02/02

01/03

01/05

01/02

01/07

100%

Personalizzazione

BIC® 4 COLOURS®

1100/1101

A SP: max. 4 col.

B DG: Digital print (area per le immagini)

C BP: full-colour

MOQ 250 pz. (SP, DG)

MOQ 100 pz. (BP)

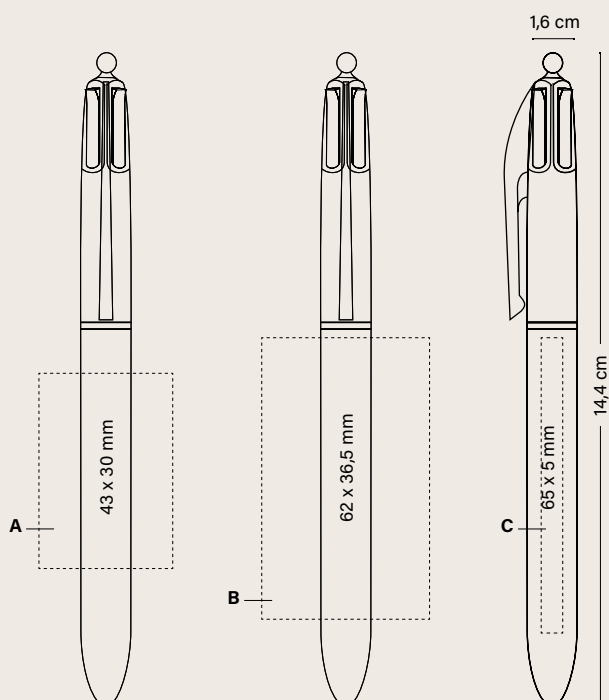

BIC® 4 COLOURS®	100-249	250-499	500-999	1000-2499	2500-4999	5000	Prezzo (€)
1100							
SP	-	3,41	3,09	2,85	2,67	2,51	
DG	-	4,66	4,22	3,92	3,64	3,44	
BP	4,51	3,68	3,33	3,10	2,90	2,73	
1101 (Lanyard)							
SP	-	3,86	3,50	3,24	3,05	2,85	
DG	-	5,11	4,64	4,29	4,00	3,79	
BP	5,06	4,14	3,75	3,48	3,27	3,08	

Costo di stampa aggiuntivo per colore e posizione

SP	-	0,17	0,14	0,14	0,14	0,13
BP	0,26	0,24	0,22	0,21	0,20	0,19
BP Texture	0,20	0,18	0,16	0,15	0,15	0,14

I prezzi includono una stampa in una posizione secondo la tecnica specificata.

CONFEZIONI SPECIALI OPZIONAL



ECO SLEEVE



PLASTIC POUCH



WINDOW BOX



COLLECTION BOX



Nuova!
Collection Box
(1, 2 e 3 pz.)

250 ± 3,2KG

+ INFO PAG. 222-227

IMBALLAGGIO ESTERNO

MARCATURA



MIX & MATCH



COLORI PERSONALIZZATI



PRODOTTO E STAMPATO NEGLI STABILIMENTI BIC

FABRIQUE EN FRANCE

PRODOTTO IN FRANCIA



CONFORMITÀ NORMATIVA



IMPRIM'VERT®



100% RICICLABILE



100% ELETTRICITÀ DA FONTI RINNOVABILI



BASSO IMPATTO AMBIENTALE

MODALITÀ DI SCRITTURA



PENNA A SFERA M

TECNICHE DI STAMPA



SERIGRAFIA



DIGITALE



BRITEPIX™

Vedere pagina 233 per una spiegazione dettagliata delle icone.

BIC® 4 COLOURS® SOFT

Una superficie morbida
che non vorrai mai
smettere di toccare!



BIC® 4 COLOURS® SOFT

1060 Opaco

1063 Con Lanyard

Colore inchiostro



01/03F



01/02F



01/07F

collection



*Senti la
morbidezza
nelle tue
mani*

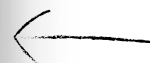

*Servizio di
ricarica su
richiesta*



BIC® 4 COLOURS® SOFT

Personalizzazione

BIC® 4 COLOURS® SOFT

1060/1063

A SP: max. 1 col.

MOQ 250 pz.

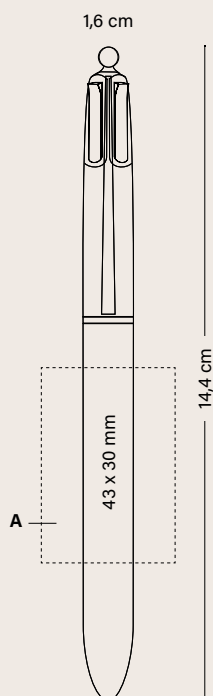

Prezzo (€)

BIC® 4 COLOURS® SOFT	250-499	500-999	1000-2499	2500-4999	5000
1060					
SP	4,06	3,67	3,40	3,18	3,00
1063 (Lanyard)					
SP	4,52	4,08	3,78	3,55	3,35

Costo di stampa aggiuntivo per colore e posizione

SP	0,17	0,14	0,14	0,14	0,13
----	------	------	------	------	------

I prezzi includono serigrafia ad un colore in una posizione.

CONFEZIONI SPECIALI OPZIONAL



ECO SLEEVE



PLASTIC POUCH



WINDOW BOX



COLLECTION BOX

Nuova!
Collection Box
(1, 2 e 3 pz.)

IMBALLAGGIO ESTERNO



250 ± 3,2KG

+ INFO PAG. 222-227

MARCATURA



COLORI PERSONALIZZATI



PRODOTTO E STAMPATO NEGLI STABILIMENTI BIC

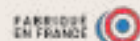

PRODOTTO IN FRANCIA



CONFORMITÀ NORMATIVA



ISO certified



IMPRIM'VERT®



100% RICICLABILE



100% ELETTRICITÀ DA FONTI RINNOVABILI



BASSO IMPATTO AMBIENTALE

MODALITÀ DI SCRITTURA



PENNA A SFERA M

TECNICHE DI STAMPA



SP SERIGRAFIA

Vedere pagina 233 per una spiegazione dettagliata delle icone.

BIC® 4 COLOURS® WOOD STYLE

Lasciati impressionare dalla spettacolare finitura in legno!



BIC® 4 COLOURS® WOOD STYLE

1061 Opaco

1064 Con Lanyard

Colore inchiostro



01/6AW

01/05W

01/02W

01/12W

collection



*Dai calore al
tuo marchio*

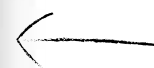

*Servizio di
ricarica su
richiesta*



BIC® 4 COLOURS® WOOD STYLE

Personalizzazione

BIC® 4 COLOURS® WOOD STYLE

1061/1064

A SP: max. 2 col.

MOQ 250 pz.

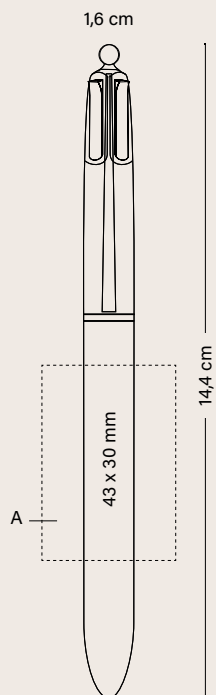

	Prezzo (€)				
BIC® 4 COLOURS® WOOD STYLE	250-499	500-999	1000-2499	2500-4999	5000
1061					
SP	4,06	3,67	3,40	3,18	3,00
1064 (Lanyard)					
SP	4,52	4,08	3,78	3,55	3,35
Costo di stampa aggiuntivo per colore e posizione					
SP	0,17	0,14	0,14	0,14	0,13

I prezzi includono serigrafia ad un colore in una posizione.

CONFEZIONI SPECIALI OPZIONAL



ECO SLEEVE



PLASTIC POUCH



WINDOW BOX



COLLECTION BOX

Nuova! Collection Box (1, 2 e 3 pz.)



250 ± 3,2KG

+ INFO PAG. 222-227

IMBALLAGGIO ESTERNO

MARCATURA



48h



COLORI PERSONALIZZATI



PRODOTTO E STAMPATO NEGLI STABILIMENTI BIC

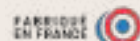

PRODOTTO IN FRANCIA



CONFORMITÀ NORMATIVA



ISO certified

IMPRIM'VERT®



100% RICICLABILE



100% ELETTRICITÀ DA FONTI RINNOVABILI



BASSO IMPATTO AMBIENTALE

MODALITÀ DI SCRITTURA



PENNA A SFERA M

TECNICHE DI STAMPA



SERIGRAFIA

Vedere pagina 233 per una spiegazione dettagliata delle icone.



LA SOLUZIONE PER
LA COMUNICAZIONE
FULL COLOUR!

BIC® 4 COLOURS® SUN

1097 Opaco
1098 Con Lanyard
Colore inchiostro
●●●●



*Colori sgargianti:
giallo & arancio*

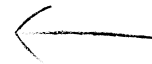

*Servizio di
ricarica su
richiesta*



01/12

01/12

100%

Personalizzazione

BIC® 4 COLOURS® SUN

1097/1098

A SP: max. 4 col.

B DG: Digital print (area per le immagini)

C BP: full-colour

MOQ 250 pz. (SP, DG)

MOQ 100 pz. (BP)

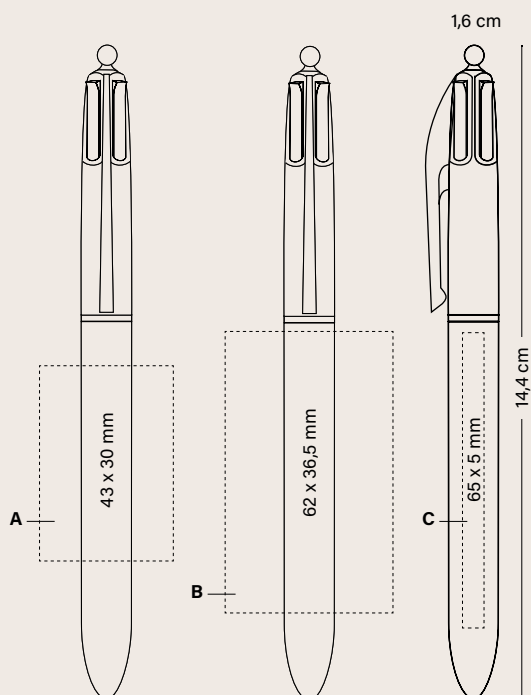

Prezzo (€)

BIC® 4 COLOURS® SUN	100-249	250-499	500-999	1000-2499	2500-4999	5000
1097						
SP	-	3,41	3,09	2,85	2,67	2,51
DG	-	4,66	4,22	3,92	3,64	3,44
BP	4,51	3,68	3,33	3,10	2,90	2,73
1098 (Lanyard)						
SP	-	3,86	3,50	3,24	3,05	2,85
DG	-	5,11	4,64	4,29	4,00	3,79
BP	5,06	4,14	3,75	3,48	3,27	3,08

Costo di stampa aggiuntivo per colore e posizione

SP	-	0,17	0,14	0,14	0,14	0,13
BP	0,26	0,24	0,22	0,21	0,20	0,19
BP Texture	0,20	0,18	0,16	0,15	0,15	0,14

I prezzi includono una stampa in una posizione secondo la tecnica specificata.

CONFEZIONI SPECIALI OPZIONAL

IMBALLAGGIO ESTERNO



+ INFO PAG. 222-227

Nuova!
Collection Box
(1, 2 e 3 pz.)

MARCATURA



COLORI PERSONALIZZATI



PRODOTTO E STAMPATO NEGLI STABILIMENTI BIC

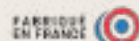

PRODOTTO IN FRANCIA



CONFORMITÀ NORMATIVA



IMPRIM'VERT®



RICICLABILE



100 % ELETTRICITÀ DA FONTI RINNOVABILI



BASSO IMPATTO AMBIENTALE

MODALITÀ DI SCRITTURA



PENNA A SFERA M

TECNICHE DI STAMPA



SERIGRAFIA



DIGITALE



BRITEPIX™
BRITEPIX™ TEXTURE
BRITEPIX™ PERSONALISATION

Vedere pagina 233 per una spiegazione dettagliata delle icone.



LA SOLUZIONE PER
LA COMUNICAZIONE
FULL COLOUR!

*Ora sui nuovi
corpi colorati*

4 COLOURS® FASHION

1102 Opaco
1108 Con Lanyard
Colore inchiostro
●●●●



Personalizzazione

BIC® 4 COLOURS® FASHION 1102/1108

A SP: max. 4 col.
B DG: Digital print (area per le immagini)
C BP: full-colour

MOQ 250 pz. (SP, DG)
MOQ 100 pz. (BP)

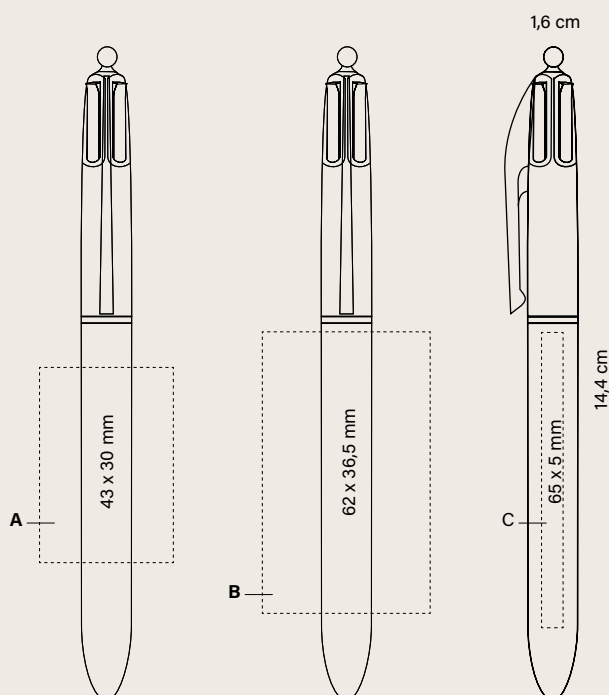

Prezzo (€)

BIC® 4 COLOURS® FASHION	100-249	250-499	500-999	1000-2499	2500-4999	5000
1102						
SP	-	3,41	3,09	2,85	2,67	2,51
DG	-	4,66	4,22	3,92	3,64	3,44
BP	4,51	3,68	3,33	3,10	2,90	2,73
1108 (Lanyard)						
SP	-	3,86	3,50	3,24	3,05	2,85
DG	-	5,11	4,64	4,29	4,00	3,79
BP	5,06	4,14	3,75	3,48	3,27	3,08

Costo di stampa aggiuntivo per colore e posizione

	100-249	250-499	500-999	1000-2499	2500-4999	5000
SP	-	0,17	0,14	0,14	0,14	0,13
BP	0,26	0,24	0,22	0,21	0,20	0,19
BP Texture	0,20	0,18	0,16	0,15	0,15	0,14

I prezzi includono una stampa in una posizione secondo la tecnica specificata.

CONFEZIONI SPECIALI OPZIONAL



ECO SLEEVE



PLASTIC POUCH



WINDOW BOX



COLLECTION BOX

Nuova!
Collection Box
(1, 2 e 3 pz.)



250 ± 3,2KG

+ INFO PAG. 222-227

IMBALLAGGIO ESTERNO

MARCATURA



COLORI PERSONALIZZATI



PRODOTTO E STAMPATO NEGLI STABILIMENTI BIC

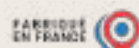

PRODOTTO IN FRANCIA



CONFORMITÀ NORMATIVA



ISO certified



IMPRIM'VERT®



100% RICICLABILE



100% ELETTRICITÀ DA FONTI RINNOVABILI



100% ELETTRICITÀ DA FONTI RINNOVABILI



BASSO IMPATTO AMBIENTALE

MODALITÀ DI SCRITTURA



PENNA A SFERA M

TECNICHE DI STAMPA



SP SERIGRAFIA



DG DIGITALE



BP BRITEPIX™
BRITEPIX™ TEXTURE
BRITEPIX™ PERSONALISATION

BIC® 4 COLOURS® SHINE

Dai Lucentezza al tuo marchio

BIC® 4 COLOURS® SHINE

1106 Opaco
1107 Con Lanyard
Colore inchiostro
● ● ● ●

collection
● ● ● ●



01/75



01/26



01/7G



01/34



01/97

*Fusti super
brillanti!*

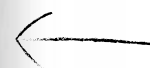

*Servizio di
ricarica su
richiesta*



BIC® 4 COLOURS® SHINE

Personalizzazione

BIC® 4 COLOURS® SHINE
1106/1107

A SP: max. 2 col.

B LE

C LE

D LE: 360°

MOQ 250 pz.

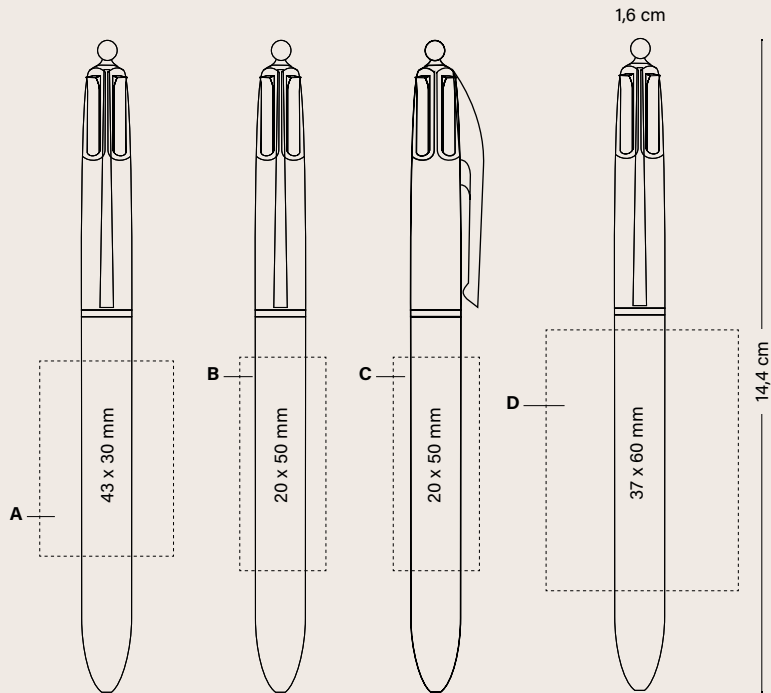

Prezzo (€)

BIC® 4 COLOURS® SHINE

1106

	250-499	500-999	1000-2499	2500-4999	5000
SP	3,90	3,51	3,27	3,06	2,85
LE	4,80	4,31	4,00	3,73	3,52
LE 360°	5,43	4,89	4,55	4,24	3,99

1107 (Lanyard)

	250-499	500-999	1000-2499	2500-4999	5000
SP	4,38	3,95	3,66	3,44	3,21
LE	5,27	4,74	4,41	4,13	3,88
LE 360°	5,92	5,34	4,95	4,64	4,36

Costo di stampa aggiuntivo per colore e posizione

SP	0,17	0,14	0,14	0,14	0,13
----	------	------	------	------	------

I prezzi includono una stampa in una posizione secondo la tecnica specificata.

CONFEZIONI SPECIALI OPZIONAL



+ INFO PAG. 222-227

ECO SLEEVE



PLASTIC POUCH



WINDOW BOX



COLLECTION BOX

*Nuova!
Collection Box
(1, 2 e 3 pz.)*



250 ± 3,2KG

IMBALLAGGIO ESTERNO

MARCATURA



COLORI PERSONALIZZATI



PRODOTTO E STAMPATO NEGLI STABILIMENTI BIC



PRODOTTO IN FRANCIA



CONFORMITÀ NORMATIVA



ISO certified



IMPRIM'VERT®



100% RICICLABILE



100% ELETTRICITÀ DA FONTI RINNOVABILI



BASSO IMPATTO AMBIENTALE

MODALITÀ DI SCRITTURA



PENNA A SFERA M

TECNICHE DI STAMPA



SP SERIGRAFIA



LE LASER

Vedere pagina 233 per una spiegazione dettagliata delle icone.

STRUMENTI DI SCRITTURA BIC® | PENNE A SFERA

BIC® 4 COLOURS® GLACÉ

La nostra penna classica in abito elegante

BIC® 4 COLOURS® GLACÉ

1057 Opaco

1058 Con Lanyard

Colore inchiostro



collection



76

47G

03G

05G

04G

14G

*Servizio di
ricarica su
richiesta*

BIC® 4 COLOURS® GLACÉ

Personalizzazione

BIC® 4 COLOURS® GLACÉ

1057/1058

A SP: max. 2 col.

MOQ 250 pz.

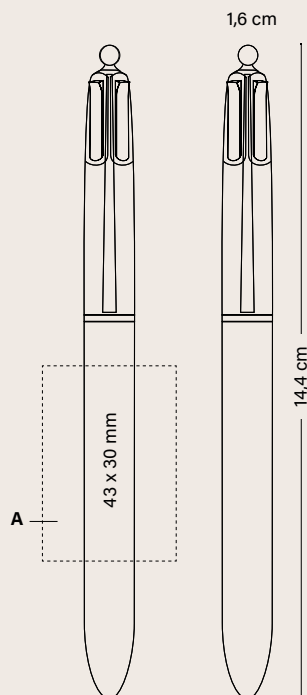

	Prezzo (€)				
BIC® 4 COLOURS® GLACÉ	250-499	500-999	1000-2499	2500-4999	5000
1057					
SP	3,90	3,51	3,27	3,06	2,85
1058 (Lanyard)					
SP	4,36	3,93	3,64	3,42	3,19
Costo di stampa aggiuntivo per colore e posizione					
SP	0,17	0,14	0,14	0,14	0,13

I prezzi includono serigrafia ad un colore in una posizione.

CONFEZIONI SPECIALI OPZIONAL



ECO SLEEVE



PLASTIC POUCH



WINDOW BOX



COLLECTION BOX

*Nuova!
Collection Box
(1, 2 e 3 pz.)*



250 ± 3,2KG

+ INFO PAG. 222-227

IMBALLAGGIO ESTERNO

MARCATURA



COLORI PERSONALIZZATI



PRODOTTO E STAMPATO NEGLI STABILIMENTI BIC

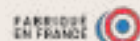

PRODOTTO IN FRANCIA



CONFORMITÀ NORMATIVA



ISO certified

IMPRIM'VERT®



100% RICICLABILE



100% ELETTRICITÀ DA FONTI RINNOVABILI



BASSO IMPATTO AMBIENTALE

MODALITÀ DI SCRITTURA



PENNA A SFERA M

TECNICHE DI STAMPA



SERIGRAFIA



IL LA SOLUZIONE PER
LA COMUNICAZIONE
FULL COLOUR!

BIC® 4 COLOURS® FINE

1109 Opaco
1111 Con Lanyard
Colore inchiostro



Servizio di ricarica su richiesta

0.8mm punta

Personalizzazione

BIC® 4 COLOURS® FINE

1109/1111

A SP: max. 4 col.
B DG: Digital print
C BP: full-colour

MOQ 250 pz. (SP, DG)
MOQ 100 pz. (BP)

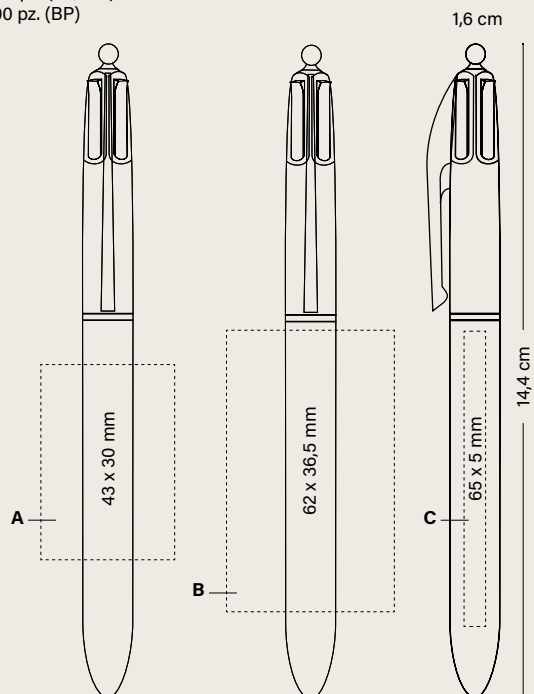

Prezzo (€)

BIC® 4 COLOURS® FINE	100-249	250-499	500-999	1000-2499	2500-4999	5000
1109						
SP	-	3,41	3,09	2,85	2,67	2,51
DG	-	4,66	4,22	3,92	3,64	3,44
BP	4,51	3,68	3,33	3,10	2,90	2,73
1111 (Lanyard)						
SP	-	3,86	3,50	3,24	3,05	2,85
DG	-	5,11	4,64	4,29	4,00	3,79
BP	5,06	4,14	3,75	3,48	3,27	3,08

Costo di stampa aggiuntivo per colore e posizione

SP	-	0,17	0,14	0,14	0,14	0,13
BP	0,26	0,24	0,22	0,21	0,20	0,19
BP Texture	0,20	0,18	0,16	0,15	0,15	0,14

I prezzi includono una stampa in una posizione secondo la tecnica specificata.

CONFEZIONI SPECIALI OPZIONALI



+ INFO PAG. 222-227

IMBALLAGGIO ESTERNO



MARCATURA



MODALITÀ DI SCRITTURA



TECNICHE DI STAMPA



Vedere pagina 233 per una spiegazione dettagliata delle icone. *Servizio 48h non disponibile per stampa Disponibile senza lanyard

4 colori di inchiostro, di cui uno è giallo fluo!

BIC® 4 COLOURS® FLUO

1114 Opaco
1116 Con Lanyard
Colore inchiostro



Servizio di ricarica su richiesta

100%

Personalizzazione

BIC® 4 COLOURS® FLUO

1114/1116

A SP: max. 4 col.
B BP: full-colour

MOQ 250 pz. (SP, DG)
MOQ 100 pz. (BP)

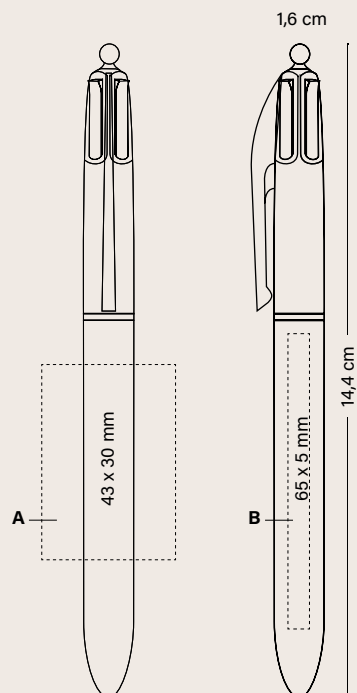

Prezzo (€)

BIC® 4 COLOURS® FLUO	100-249	250-499	500-999	1000-2499	2500-4999	5000
1114						
SP	-	3,69	3,33	3,09	2,89	2,73
BP	4,51	3,96	3,58	3,32	3,11	2,94
1116 (Lanyard)						
SP	-	4,18	3,78	3,49	3,28	3,10
BP	5,40	4,45	4,02	3,72	3,50	3,31

Costo di stampa aggiuntivo per colore e posizione

SP	-	0,17	0,14	0,14	0,14	0,13
BP	0,26	0,24	0,22	0,21	0,20	0,19
BP Texture	0,20	0,18	0,16	0,15	0,15	0,14

I prezzi includono una stampa in una posizione secondo la tecnica specificata.

CONFEZIONI SPECIALI OPZIONALI

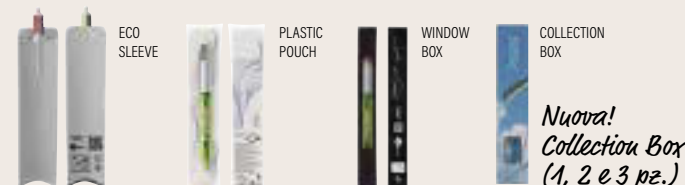

+ INFO PAG. 222-227

IMBALLAGGIO ESTERNO



MARCATURA



COLORI PERSONALIZZATI



PRODOTTO E STAMPATO NEGLI STABILIMENTI BIC



CONFORMITÀ NORMATIVA



ISO certified



RICICLABILE



100 % ELETTRICITÀ DA FONTI RINNOVABILI



BASSO IMPATTO AMBIENTALE

MODALITÀ DI SCRITTURA



PENNA A SFERA F

TECNICHE DI STAMPA



SERIGRAFIA



BRITEPIX™

BIC® 4 COLOURS® 3+1^{HB}
1099 Opaco
Colore inchiostro
●●●●

3 penne + 1 matita portamine!



*Servizio di
ricarica su
richiesta*



Personalizzazione

BIC® 4 COLOURS® 3+1^{HB}

1099 Opaco

A/B LE

MOQ 250 pz.
Combinazione colori standard

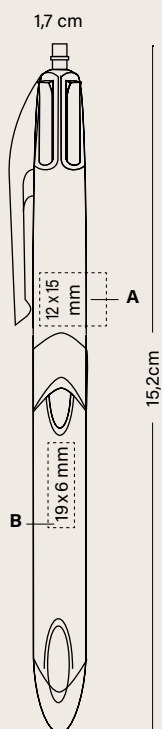

Prezzo (€)

BIC® 4 COLOURS® 3+1^{HB} 250-499 500-999 1000-2499 2500-4999 5000

1099

LE	5,12	4,63	4,30	4,00	3,79
-----------	------	------	------	------	------

Costo di stampa aggiuntivo per colore e posizione

LE	1,27	1,14	1,01	1,01	1,01
-----------	------	------	------	------	------

I prezzi includono una incisione laser in una posizione.

CONFEZIONI SPECIALI OPZIONALI



PLASTIC
POUCH



COLLECTION
BOX

*Nuova!
Collection Box
(1, 2 e 3 pz.)*

+ INFO PAG. 222-227

IMBALLAGGIO ESTERNO



250 ± 3,5 KG

MARCATURA



COLORI
PERSONALIZZATI



PRODOTTO E STAMPATO
NEGLI STABILIMENTI BIC



CONFORMITÀ
NORMATIVA



IMPRIM'VERT®



100%
RICICLABILE



100 % ELETTRICITÀ
DA FONTI RINNOVABILI



BASSO IMPATTO
AMBIENTALE

**MODALITÀ
DI SCRITTURA**



PENNA A SFERA M



PORTAMINE
MP Ø 0,7MM

**TECNICHE
DI STAMPA**



LE
LASER



GUARDA IL VIDEO

Vedere pagina 233 per una spiegazione dettagliata delle icone.

BIC® METAL PRO

Particolari metallici, design moderno e con una ampia selezione di colori e finiture.

BIC® METAL PRO

1290 Soft

Colore inchiostro



01F



10F*



03F*



02F



04F

Massimo comfort di scrittura

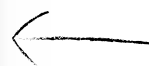

Inchiostro fabbricato in Germania, ti permette di scrivere fino a 8 Km

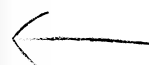

BIC® METAL PRO

1290 Lucido

Colore inchiostro



01E

02E

03E*

05E*

04E

06P*

100%

MARCATURA



ASSEMBLAGGIO E STAMPA
NEGLI STABILIMENTI BIC



PRODOTTO IN
GERMANIA



CONFORMITÀ
NORMATIVA



ISO
certified



IMPRIM'VERT®



100%
RICICLABILE

MODALITÀ DI SCRITTURA



PENNA A SFERA M

TECNICHE DI STAMPA



SP
SERIGRAFIA



LE
LASER

Vedere pagina 233 per una spiegazione dettagliata delle icone.

BIC® METAL PRO

1290 Mate

Colore inchiostro



01D

10D*

03D*

02D

04D

100%

Personalizzazione

BIC® METAL PRO

1290

A SP: max. 2 col.

(Non disponibile nella finitura soft)

B LE/SP: max. 1 col.

C LE 360°

MOQ 50 pz.

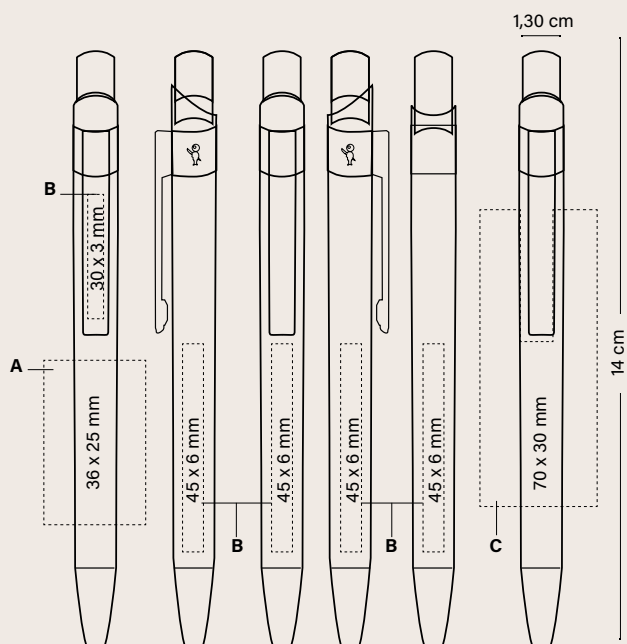

	Prezzo (€)			
BIC® METAL PRO	50-99	100-249	250-499	500-1000
1290				
SP	4,88	4,58	4,37	4,16
LE	6,73	5,62	5,32	5,02
LE 360° (quantità minima 100 unità)	-	7,94	6,38	5,96

Costo di stampa aggiuntivo per colore e posizione

SP	0,45	0,42	0,37	0,32
LE	1,66	1,42	1,29	1,17

I prezzi includono una stampa in una posizione secondo la tecnica specificata.

CONFEZIONI SPECIALI OPZIONALI



+ INFO PAG. 222-227

IMBALLAGGIO ESTERNO



MARCATURA



PRODOTTO E STAMPATO
NEGLI STABILIMENTI BIC



PRODOTTO IN
GERMANIA



CONFORMITÀ
NORMATIVA



ISO
certified



IMPRIM'VERT®



100%
RICICLABILE

**MODALITÀ
DI SCRITTURA**



PENNA A SFERA M

**TECNICHE DI
STAMPA**



SP
SERIGRAFIA



LE
LASER



BIC[®] CRISTAL[®] RE'NEW[™]

L'iconica BIC[®] Cristal[®] in versione metallica. Penna a sfera ricaricabile premium BIC[®] Cristal[®] Re'New[™] con inchiostro blu o nero e 2 ricariche incluse per continuare a scrivere a lungo. La penna presenta un resistente corpo in metallo argentato opaco e un cappuccio in plastica riciclata al 96%.

La stessa ingegnosa forma esagonale dell'originale BIC[®] Cristal[®] per una buona impugnatura e comfort. Design sostenibile, qualità e valore senza tempo. Il prodotto viene fornito nella scatola BIC[®] Window box.

BIC® CRISTAL®
RE'NEW™

1090

Colore inchiostro



1 penna + 2 ricariche

BIC® WINDOW BOX

*La tua Cristal® Re'New™
sempre con questa confezione!!*

(Inclusa nel prezzo)

Personalizzazione

BIC® CRISTAL® RE'NEW™
1090

A LE: max. 1 col.

MOQ 25 pz.

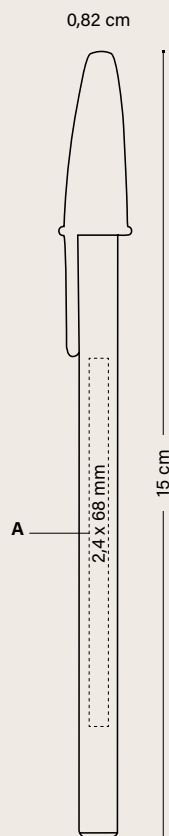

Prezzo (€)

BIC® CRISTAL® RE'NEW™	25-49	50-99	100-249	250-499	500-1000
1090					
LE	7,47	6,95	6,44	6,18	5,92

Costo di stampa aggiuntivo per colore e posizione

LE	1,98	1,66	1,42	1,29	1,17
----	------	------	------	------	------

I prezzi includono una incisione laser in una posizione.

IMBALLAGGIO ESTERNO



44 ± 1KG

MARCATURA



PRODOTTO E STAMPATO
NEGLI STABILIMENTI BIC



CONFORMITÀ
NORMATIVA



IMPRIM'VERT®



RICICLABILE

MODALITÀ
DI SCRITTURA



PENNA A SFERA M

TECNICHE DI
STAMPA



LASER



BIC[®] GRIP ROLLER

Goditi un'esperienza di scrittura morbidissima.
Scorre facilmente sulla carta senza macchiare
grazie all' inchiostro ad asciugatura immediata,
ideale per mancini e destri.

BIC® GRIP ROLLER



SCRITTURA MEDIA
Ø 0,7 MM

Inchiostro liquido a punta media di alta qualità penna roller per una scrittura fluida

BIC® GRIP ROLLER

1187

Colore inchiostro



01/35

12/35

10/35

03/35

59/35

24/35

07/35

06/35

27/35

02/35

14/35

Anche disponibile
con inchiostro blu

Anche disponibile
con inchiostro blu

Anche disponibile
con inchiostro blu

100%

Personalizzazione

BIC® GRIP ROLLER
1187

A/B SP: max. 3 col.

MOQ 250 pz.

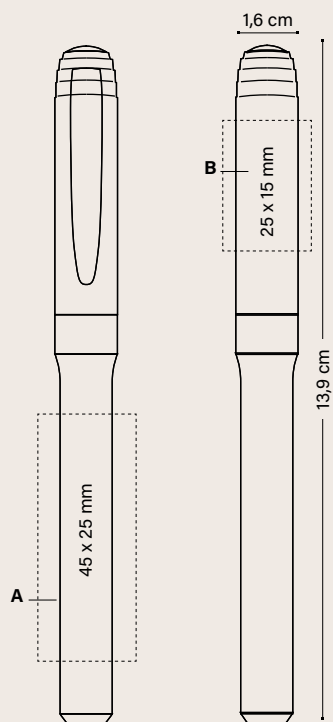

	Prezzo (€)				
BIC® GRIP ROLLER	250-499	500-999	1000-2499	2500-4999	5000
1187					
SP	1,86	1,68	1,56	1,46	1,37

Costo di stampa aggiuntivo per colore e posizione

SP	0,17	0,14	0,14	0,14	0,13
-----------	------	------	------	------	------

I prezzi includono serigrafia ad un colore in una posizione.

CONFEZIONI SPECIALI OPZIONALI



ECO SLEEVE

PLASTIC POUCH

WINDOW BOX

MARKING SET

COLLECTION BOX

+ INFO PAG. 222-227

IMBALLAGGIO ESTERNO



250 ± 3 KG

Nuova! Collection Box
(1, 2 e 3 pz.)

MARCATURA



PRODOTTO E STAMPATO
NEGLI STABILIMENTI BIC



CONFORMITÀ
NORMATIVA



IMPRIM'VERT®



RICICLABILE

**MODALITÀ DI
SCRITTURA**



ROLLER R
Ø 0,7 MM

**TECNICHE DI
STAMPA**



SERIGRAFIA

Vedere pagina 233 per una spiegazione dettagliata delle icone.

BIC® XS FINESTYLE

1851 Opaco
Colore inchiostro



01/03



01/25



01/06

BIC® XS FINESTYLE

1851 Trasparente
Colore inchiostro



100%

89/01

Personalizzazione

BIC® XS FINESTYLE

1851

A PD: max. 2 col.

B SP: max. 2 col.

C BP: a todo color

MOQ 250 pz.

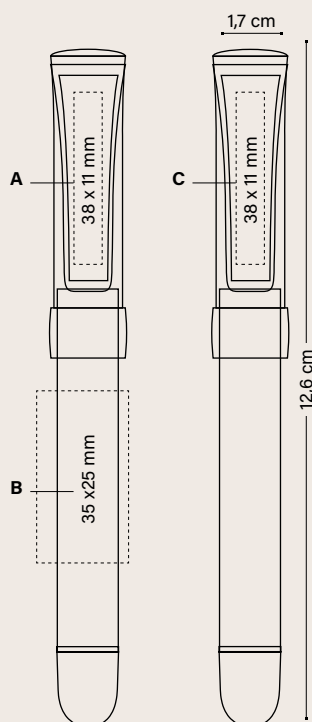

	Prezzo (€)				
BIC® XS FINESTYLE	250-499	500-999	1000-2499	2500-4999	5000
1851					
SP/PD	1,97	1,72	1,61	1,50	1,40
BP	2,24	1,95	1,83	1,71	1,59

Costo di stampa aggiuntivo per colore e posizione

SP/PD	0,17	0,14	0,14	0,14	0,13
BP Texture	0,18	0,16	0,15	0,15	0,14

I prezzi includono una stampa in una posizione secondo la tecnica specificata.

Esatta corrispondenza di colore: **≥ 10.000 pz.**

CONFEZIONI SPECIALI OPZIONALI



ECO SLEEVE



PLASTIC POUCH

+ INFO PAG. 222-227

IMBALLAGGIO ESTERNO



250 ± 2,8KG

MARCATURA



PRODOTTO E STAMPATO NEGLI STABILIMENTI BIC



PRODOTTO IN SPAGNA



CONFORMITÀ NORMATIVA



ISO certified



IMPRIM'VERT®



100% RICICLABILE



100% ELETTRICITÀ DA FONTI RINNOVABILI



BASSO IMPATTO AMBIENTALE

MODALITÀ DI SCRITTURA



SCRITTURA FINESTYLE Ø 0,7 MM

TECNICHE DI STAMPA



SERIGRAFIA



STAMPA A TAMPONE



BRITEPIX™
BRITEPIX™
TEXTURE
BRITEPIX™
PERSONALISATION

Vedere pagina 233 per una spiegazione dettagliata delle icone.

BIC® INTENSITY® GEL CLIC



*L'iconico BIC® Boy
in rilievo*

BIC® INTENSITY® GEL CLIC

1196 Opaco
Colore inchiostro



01



02

100%

BIC® INTENSITY® GEL CLIC

1196 Trasparente
Colore inchiostro



92



88



86

100%

Personalizzazione

BIC® INTENSITY® GEL CLIC

1196

A SP: max. 2 col.

B SP: max. 4 col.

MOQ 250 pz.

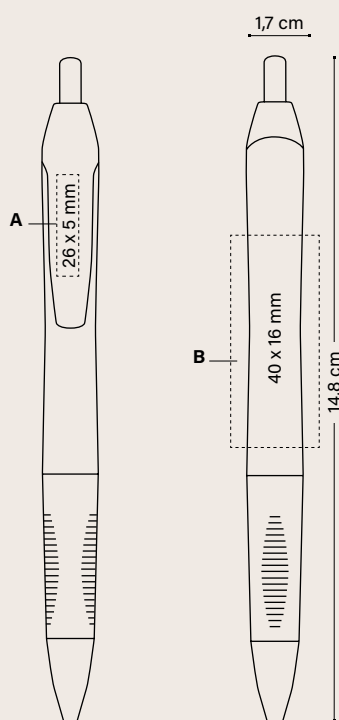

	Prezzo (€)				
BIC® INTENSITY® GEL CLIC	250-499	500-999	1000-2499	2500-4999	5000
1196					
SP	2,91	2,63	2,44	2,27	2,15
Costo di stampa aggiuntivo per colore e posizione					
SP	0,17	0,14	0,14	0,14	0,13

I prezzi includono serigrafia ad un colore in una posizione.

CONFEZIONI SPECIALI OPZIONALI



+ INFO PAG. 222-227

IMBALLAGGIO ESTERNO



MARCATURA



PRODOTTO E STAMPATO NEGLI STABILIMENTI BIC



CONFORMITÀ NORMATIVA



ISO certified



IMPRIM'VERT®



RICICLABILE

MODALITÀ DI SCRITTURA



GEL G Ø 0,7 MM

TECNICHE DI STAMPA



SERIGRAFIA

Vedere pagina 233 per una spiegazione dettagliata delle icone.



EVIDENZIATORI E PENNARELLI BIC®

BIC® ti offre prodotti appositamente progettati per scrivere in modo ben visibile su superfici e materiali su cui altri strumenti di scrittura non possono scrivere. Rendi visibili le tue idee ed esprimiti su qualsiasi superficie con pennarelli BIC®.

BIC® Brite Liner® Grip

BIC® Velleda® White Board Marker Fine

BIC® Velleda® White Board Marker Grip

BIC® Mark-It Permanent Marker

BIC® Permanent Marker Ecolutions®

BIC® BRITE LINER® GRIP

BIC® BRITE LINER® GRIP
1192



*Grip di gomma
per una maggiore
precisione e
controllo*

12
●
Colore
inchiostro

10
●
Colore
inchiostro

24
●
Colore
inchiostro

59
●
Colore
inchiostro

14
●
Colore
inchiostro

Personalizzazione

BIC® BRITE LINER® GRIP

1192

A/B SP: max. 3 col.

MOQ 250 pz.

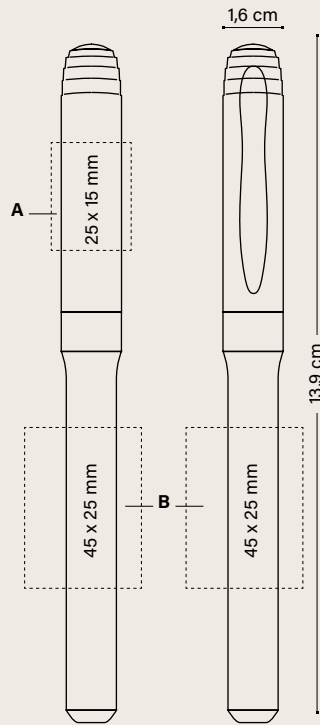

	Prezzo (€)				
BIC® BRITE LINER® GRIP	250-499	500-999	1000-2499	2500-4999	5000
1192					
SP	1,67	1,54	1,42	1,31	1,23

Costo di stampa aggiuntivo per colore e posizione

SP	0,17	0,14	0,14	0,14	0,13
-----------	------	------	------	------	------

I prezzi includono serigrafia ad un colore in una posizione.

CONFEZIONI SPECIALI OPZIONALI



+ INFO PAG. 222-227



MARKING SET



COLLECTION BOX

Ora puoi averlo in set!

IMBALLAGGIO ESTERNO



250 ± 2,8KG

MARCATURA



PRODOTTO E STAMPATO NEGLI STABILIMENTI BIC



CONFORMITÀ NORMATIVA



ISO certified
IMPRIM'VERT®



100%
RICICLABILE



NON SI SECCA 24H

MODALITÀ DI SCRITTURA



EVIDENZIATORE HL

TECNICHE DI STAMPA



SP
SERIGRAFIA

ADATTO PER



FAX



FOTOCOPIE



STAMPANTI



CARTA

Vedere pagina 233 per una spiegazione dettagliata delle icone.

BIC® VELLEDA® WHITE BOARD MARKER FINE

Velleda®

BIC® VELLEDA® WHITE BOARD MARKER FINE
1651



Personalizzazione

BIC® VELLEDA® WHITE BOARD MARKER FINE
1651

A SP: max. 1 col.

MOQ 500 pz.

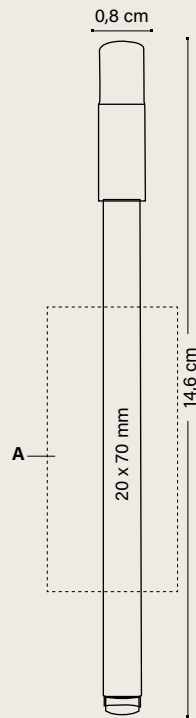

Prezzo (€)

BIC® VELLEDA® WHITE BOARD MARKER FINE

1651

SP	500-999	1000-2499	2500-4999	5000
	0,60	0,54	0,51	0,48

I prezzi includono serigrafia ad un colore in una posizione.

CONFEZIONI SPECIALI OPZIONALI



MARKING SET

Ora puoi averlo in set!

IMBALLAGGIO ESTERNO



500 ± 3,2KG

+ INFO PAG. 222-227

MARCATURA



PRODOTTO E STAMPATO NEGLI STABILIMENTI BIC



PRODOTTO IN FRANCIA



CONFORMITÀ NORMATIVA



RICICLABILE



BASSO IMPATTO AMBIENTALE



LUNTA RESISTENTE HL



PENNARELLO MK

MODALITÀ DI SCRITTURA

TECNICHE DI STAMPA



SERIGRAFIA

BIC® VELLEDA® WHITE BOARD MARKER GRIP

Velleda®

BIC® VELLEDA® WHITE BOARD MARKER GRIP
1213



100%

01/02
●
Colore inchiostro

→
Grip di gomma per una maggiore precisione e controllo

Personalizzazione

BIC® VELLEDA® WHITE BOARD MARKER GRIP
1213

A/B SP: max. 3 col.

MOQ 250 pz.

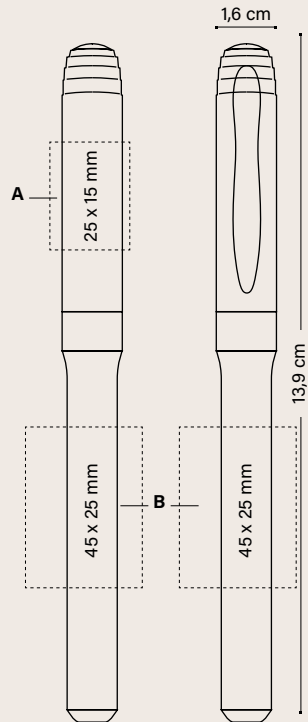

Prezzo (€)

BIC® VELLEDA® WHITE BOARD MARKER GRIP

1213	250-499	500-999	1000-2499	2500-4999	5000
SP	1,64	1,48	1,37	1,27	1,19

Costo di stampa aggiuntivo per colore e posizione

SP	0,17	0,14	0,14	0,14	0,13
----	------	------	------	------	------

I prezzi includono serigrafia ad un colore in una posizione.

CONFEZIONI SPECIALI OPZIONALI

IMBALLAGGIO ESTERNO



MARKING SET

Ora puoi averlo in set!



250 ± 2,7KG

+ INFO PAG. 222-227

MARCATURA



PRODOTTO E STAMPATO NEGLI STABILIMENTI BIC



CONFORMITÀ NORMATIVA



ISO certified



IMPRIM'VERT®



RICICLABILE



UNTA RESISTENTE HL

MODALITÀ SCRITTURA



PENNARELLO LAVAGNA BIANCA MK

TECNICHE DI STAMPA



SERIGRAFIA

BIC® MARK-IT PERMANENT MARKER

**BIC® MARK-IT
PERMANENT
MARKER**
1214



01/02
●
Colore
inchiostro

01/04
●
Colore
inchiostro

100%

←
*Grip di
gomma per
una maggiore
precisione e
controllo*

Personalizzazione

**BIC® MARK-IT
PERMANENT MARKER**
1214

A/B SP: max. 3 col.

MOQ 250 pz.

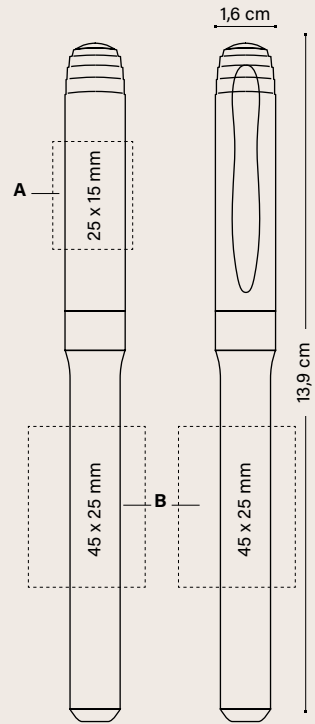

	Prezzo (€)				
BIC® MARK-IT PERMANENT MARKER 1214	250- 499	500- 999	1000- 2499	2500- 4999	5000
SP	1,61	1,45	1,35	1,25	1,17

Costo di stampa aggiuntivo per colore e posizione					
SP	0,17	0,14	0,14	0,14	0,13

I prezzi includono serigrafia ad un colore in una posizione.

CONFEZIONI SPECIALI OPZIONALI

IMBALLAGGIO ESTERNO



MARKING
SET

*Ora puoi
averlo in set!*



250 ± 2,8KG

+ INFO PAG. 222-227

MARCATURA



PRODOTTO E STAMPATO
NEGLI STABILIMENTI BIC



CONFORMITÀ
NORMATIVA



RICICLABILE



BASSO IMPATTO
AMBIENTALE



PUNTA
RESISTENTE

MODALITÀ DI SCRITTURA



PENNARELLO
MK

TECNICHE DI STAMPA



SERIGRAFIA

BIC® PERMANENT MARKER ECOLUTIONS®

ecolutions®

ecolutions®



REALIZZATA CON IL
51% DI MATERIALE RICICLATO*

Aggiungi il Mobius loop alla tua grafica senza costi addizionali. Si prega di specificarlo nell'ordine. La stampa del Mobius loop viene fatta di default nell'angolo a sinistra.



IMBALLAGGI
FARMACEUTICI

BIC® PERMANENT MARKER ecolutions® 1210



02

●
Colore inchiostro

02

●
Colore inchiostro

100%

Personalizzazione

BIC® PERMANENT MARKER ecolutions® 1210

A SP: max. 1 col.

MOQ 250 pz.

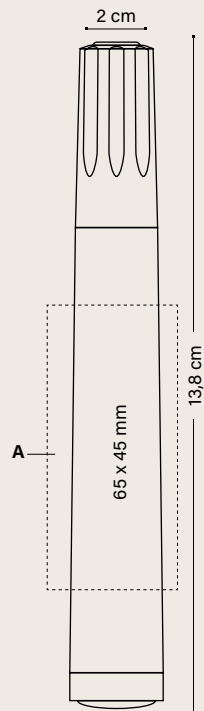

	Prezzo (€)				
BIC® PERMANENT MARKER ecolutions® 1210	250-499	500-999	1000-2499	2500-4999	5000
SP	1,90	1,73	1,60	1,50	1,41

I prezzi includono serigrafia ad un colore in una posizione.

IMBALLAGGIO ESTERNO



250 ± 2,6KG

MARCATURA



PRODOTTO E STAMPATO NEGLI STABILIMENTI BIC

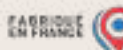

PRODOTTO IN FRANCIA



CONFORMITÀ NORMATIVA



IMBALLAGGI FARMACEUTICI



RICICLABILE



BASSO IMPATTO AMBIENTALE



PUNTA RESISTENTE



PENNARELLO MK



SERIGRAFIA

MODALITÀ DI SCRITTURA TECNICHE DI STAMPA

* La percentuale viene calcolata sul peso totale del prodotto escluso il sistema d'inchiostro. A causa del contenuto riciclato delle materie prime con cui è realizzato il prodotto, non siamo in grado di garantire che i colori che appaiono in catalogo, né quelli personalizzati su richiesta, abbiano sempre lo stesso colore e aspetto. Vedere pagina 233 per una spiegazione dettagliata delle icone.



PORTAMINE BIC®

Sempre pronto con questo portamine di qualità superiore.
È solido e resistente, non ha bisogno di essere temperato e
scrive in modo più fluido e intenso che mai!

BIC® Matic®

BIC® Media Clic Portamine

54

BIC® Media Clic Grip Portamine

58

Versione ECO.
Allo stesso prezzo della versione standard!

ecolutions®



REALIZZATA CON IL
65% DI MATERIALE RICICLATO*

Aggiungi il Mobius loop alla tua grafica senza costi aggiuntivi. Si prega di specificarlo nell'ordine. La stampa del Mobius loop viene fatta di default nell'angolo a sinistra.



IMBALLAGGI
FARMACEUTICI

BIC® MATIC®
1120 Opaco



01/05*

02/02

12/12*

03/03

07/07

01/01

100%

BIC® MATIC®
QUARTZ
1121 Opaco



51/07*

100%

BIC® MATIC®
ecolutions® 1E40 Opaco



06/8C*

04/8C*

100%

*Fino ad esaurimento scorte
**La percentuale è calcolata sul peso totale del prodotto. A causa del contenuto riciclato delle materie prime con cui è realizzato il prodotto, non siamo in grado di garantire che i colori che appaiono in catalogo, né quelli personalizzati su richiesta, abbiano sempre lo stesso colore e aspetto.

Personalizzazione

BIC® MATIC®
1120
ecolutions® 1E40

BIC® MATIC® QUARTZ

1121
A SP: max. 1 col.
(Non disponibile per
BIC® Matic® Quartz)
B/C SP: max. 2 col.

MOQ 500 pz.

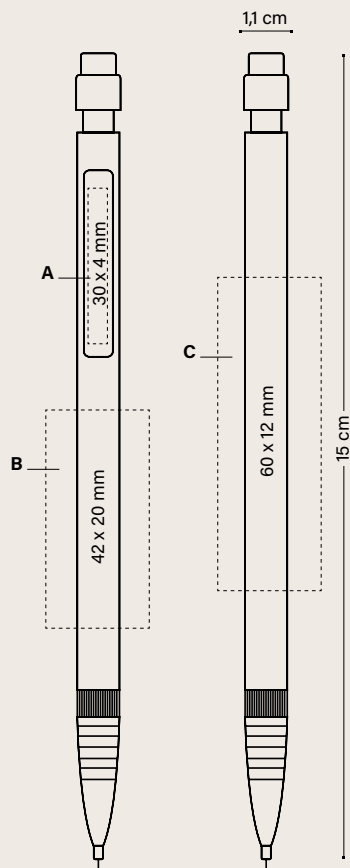

	Prezzo (€)			
BIC® MATIC®	500-999	1000-2499	2500-4999	5000
1120/ ecolutions® 1E40				
SP	0,82	0,77	0,71	0,67
1121				
SP	0,89	0,82	0,77	0,72
Costo di stampa aggiuntivo per colore e posizione				
SP	0,14	0,14	0,14	0,13

I prezzi includono serigrafia ad un colore in una posizione.

CONFEZIONI SPECIALI OPZIONALI



PLASTIC
POUCH

+ INFO PAG. 222-227

IMBALLAGGIO ESTERNO



500 ± 3,1 KG

MARCATURA



PRODOTTO E STAMPATO
NEGLI STABILIMENTI BIC



PRODOTTO IN FRANCIA



CONFORMITÀ
NORMATIVA



ISO
certified



IMPRIM'VERT®

ecolutions®



IMBALLAGGI
FARMACEUTICI



100%
RECICLABILE



BASSO IMPATTO
AMBIENTALE



SCRITTURA PIÙ
DELICATA E SCURA



FACILE DA USARE E
DA CANCELLARE



2 MINE DI 9 CM

**MODALITÀ
DI SCRITTURA**



PORTAMINE MP
Ø 0,7 MM

**TECNICHE DI
STAMPA**



SP
SERIGRAFIA

Vedere pagina 233 per una spiegazione dettagliata delle icone.



MATITE BIC®

Matita senza legno realizzata in resina sintetica riciclata che non produce schegge in caso di rottura. Mina HB in grafite ultraresistente.

Evolution® Ecolutions®



LA SOLUZIONE PER
LA COMUNICAZIONE
FULL COLOUR



LA SOLUZIONE PER
LA COMUNICAZIONE
FULL COLOUR



L'iconico marchio
BIC® in rilievo!

ecolutions®



REALIZZATA CON IL 60%
DI MATERIALE RICICLATO**



FRIGORIFERI E
CONTENITORI DI YOGURT

ecolutions®



REALIZZATA CON IL 52,7%
DI MATERIALE RICICLATO**



FRIGORIFERI E
CONTENITORI DI YOGURT

MATITA DI GRAFITE
SENZA GOMMA
ecolutions® 1150

MATITA GRAFICA
CON GOMMA
ecolutions® 1151

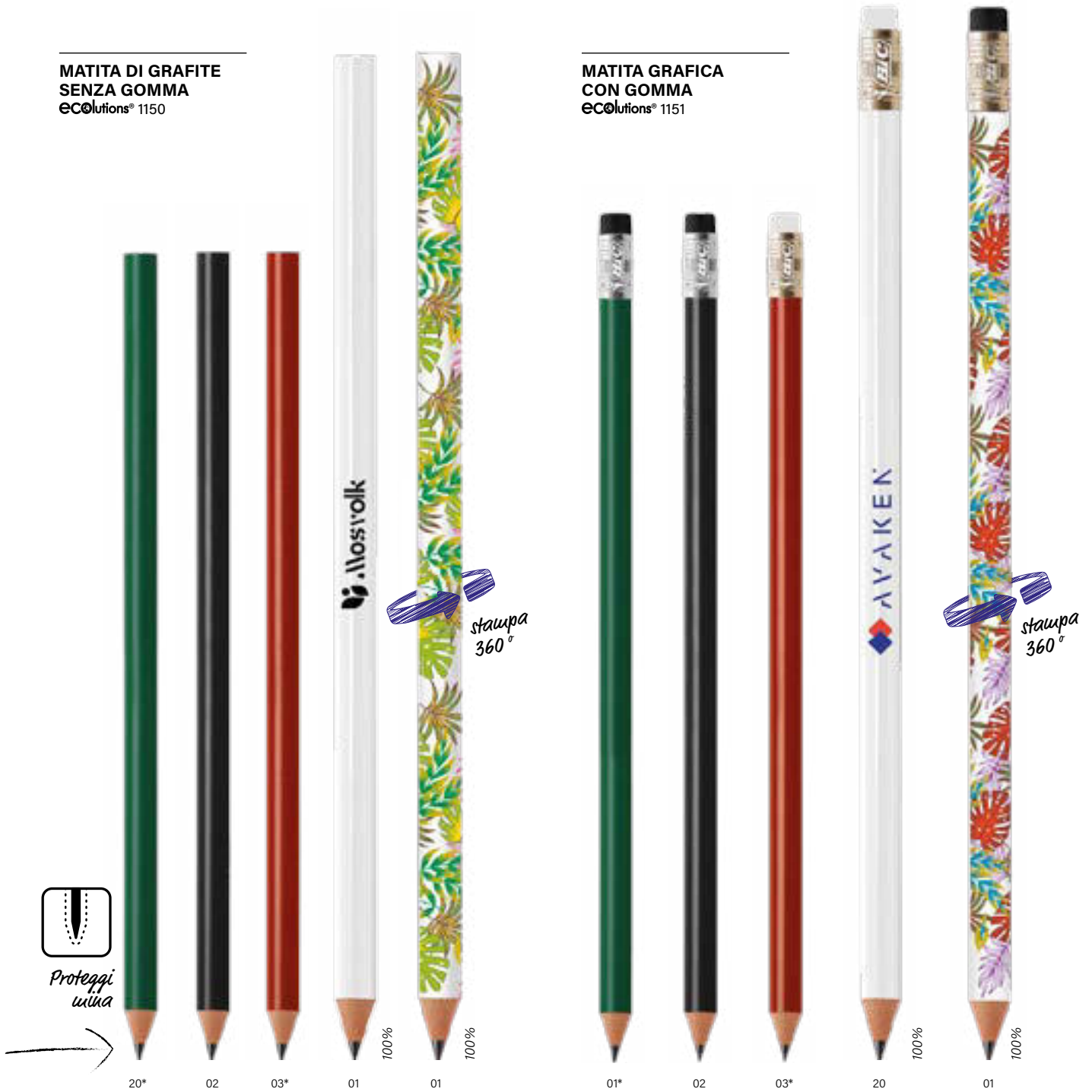

**La percentuale è calcolata sul peso totale del prodotto. A causa del contenuto riciclato delle materie prime con cui è realizzato il prodotto, non siamo in grado di garantire che i colori che appaiono in catalogo, né quelli personalizzati su richiesta, abbiano sempre lo stesso colore e aspetto.
***Servizio 48h non disponibile per stampa digitale.

ecolutions®
 REALIZZATA CON IL 60%
 DI MATERIALE RICICLATO**



Aggiungi il Mobius loop alla tua grafica senza costi addizionali. Si prega di specificarlo nell'ordine. La stampa del Mobius loop viene fatta di default nell'angolo a sinistra.

**MATITA DI GRAFITE CON
 E SENZA GOMMA**
 1150/1151

MOQ 500 pz.
 Combinazione colori standard

Gomma



Opaco



Ferula

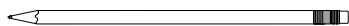

Opaco



Fusto



Opaco

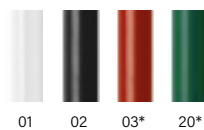

Nessun costo aggiuntivo

MARCATURA



PRODOTTO E STAMPATO
 NEGLI STABILIMENTI BIC

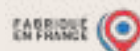

PRODOTTO IN FRANCIA



CONFORMITÀ
 NORMATIVA



IMPRIM'VERT®

ecolutions®



RICICLABILE



BASSO IMPATTO
 AMBIENTALE



PUNTA RESISTENTE



NON SI
 SCHEGGIA



PROTEGGI
 MINA



FACILE DA USARE
 E DA CANCELLARE

**MODALITÀ
 DI SCRITTURA**



MATITA PC HB
 Ø 2,3MM

**TECNICHE DI
 STAMPA**



SERIGRAFIA



DIGITALE

Vedere pagina 233 per una spiegazione dettagliata delle icone.

*Fino ad esaurimento scorte.



Personalizzazione

BIC® EVOLUTION® ECOLUTIONS®
ecolutions® 1150 (Matita senza gomma)

A SP: max. 1 col.

MOQ 500 pz.

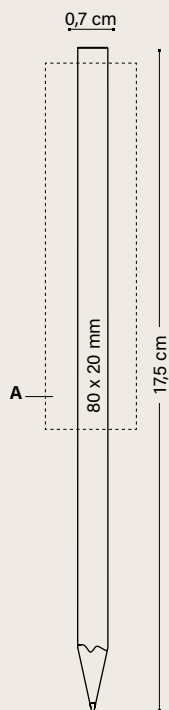

Personalizzazione

BIC® EVOLUTION® ECOLUTIONS®
ecolutions® 1151 (Matita con gomma)

MOQ 500 pz.

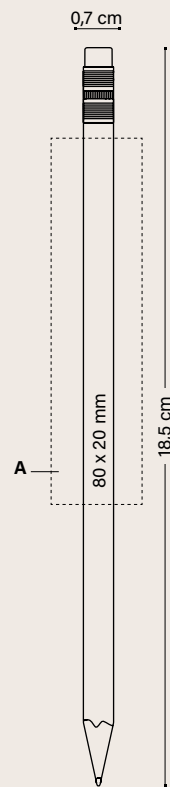

				Prezzo (€)
BIC® EVOLUTION® ecolutions®	500-999	1000-2499	2500-4999	5000
1150				
SP	0,49	0,46	0,43	0,41
1151				
SP	0,83	0,78	0,73	0,69

I prezzi includono serigrafia ad un colore in una posizione.

CONFEZIONI SPECIALI OPZIONALI



PLASTIC
 POUCH
 (x 3 PZ.)

*Ora puoi
 averlo in set!*

+ INFO PAG. 222-227

IMBALLAGGIO ESTERNO



500 ± 3,5 KG

Personalizzazione

BIC® EVOLUTION® ECOLUTIONS®
ecolutions® 1150 (Matita senza gomma digitale)

A DG: full-colour (area per le immagini)
B DG: full-colour (area per il testo)

MOQ 500 pz.

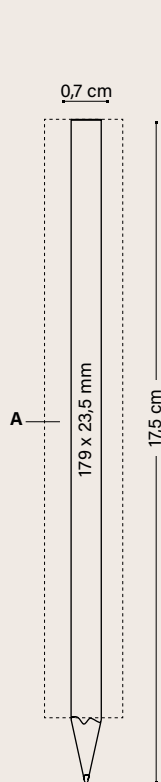

Personalizzazione

BIC® EVOLUTION® ECOLUTIONS®
ecolutions® 1151 (Matita con gomma digitale)

MOQ 500 pz.

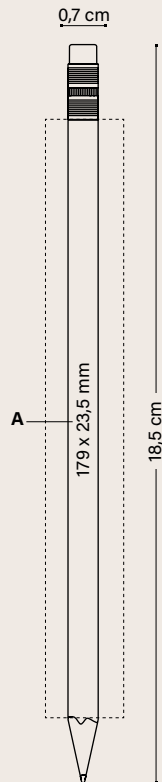

	Prezzo (€)			
	500-999	1000-2499	2500-4999	5000
BIC® EVOLUTION® ecolutions®				
1150				
DG	0,76	0,73	0,68	0,63
1151				
DG	1,11	1,04	0,97	0,91

I prezzi includono stampa digitale sul corpo.

CONFEZIONI SPECIALI OPZIONALI



PLASTIC
POUCH
(X 3 PZ.)

*Ora puoi
averlo in set!*

+ INFO PAG. 222-227

IMBALLAGGIO ESTERNO



500 ± 3,5 KG

MARCATURA



PRODOTTO E STAMPATO
NEGLI STABILIMENTI BIC

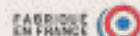

PRODOTTO IN FRANCIA



CONFORMITÀ
NORMATIVA



FRIGORIFERI E
CONTENITORI DI YOGURT



RICICLABILE



BASSO IMPATTO
AMBIENTALE



PUNTA RESISTENTE



NON SI SCHEGGIA



PROTEGGI
MINA



FACILE DA USARE
E DA CANCELLARE

**MODALITÀ
DI SCRITTURA**



MATITA PC HB
Ø 2,3MM

**TECNICHE DI
STAMPA**



SERIGRAFIA



DIGITALE

Vedere pagina 233 per una spiegazione dettagliata delle icone.

SPROUT™ MATITA DI GRAFITE



L'unica matita al mondo che può essere piantata dopo essere stata usata, e crescerà come un'erba, un ortaggio o un fiore.

SPROUT™ MATITA DI GRAFITE
53062



Fusto Standard

Fusti Personalizzabili

Cartoncino Standard

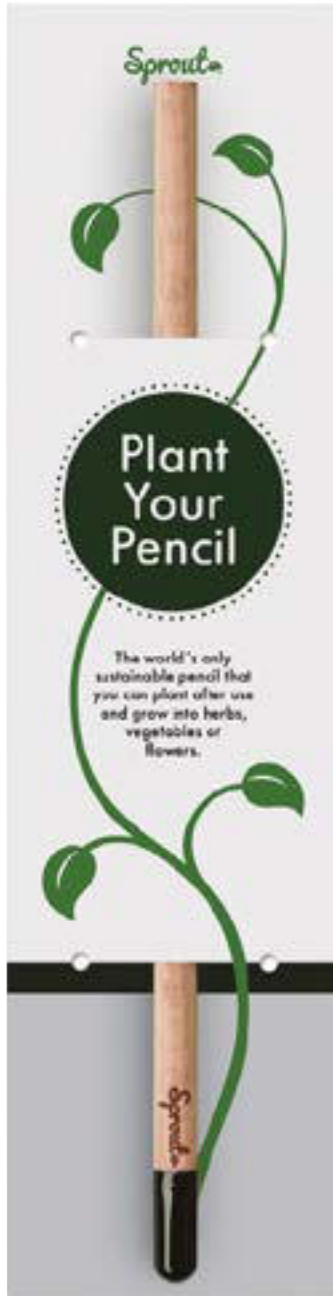

Cartone non personalizzabile

80%

Cartoncino personalizzabile



Cartone personalizzabile

80%



Parte posteriore



Punta in Grafite

Quando la matita diventa troppo corta per scrivere, si può piantare trasformando il proprio messaggio in un bellissimo vaso di erbe aromatiche, fiori o verdure.

Scegli tra 11 semi diversi

- | | | |
|----------------------|--------------------------------|-------------------------------|
| 1. <i>Abete</i> | 5. <i>Non ti scordar di me</i> | 9. <i>Coriandolo</i> |
| 2. <i>Girasole</i> | 6. <i>Basilico</i> | 10. <i>Chia</i> |
| 3. <i>Margherita</i> | 7. <i>Tiùo</i> | 11. <i>Powodoro ciliegino</i> |
| 4. <i>Garofano</i> | 8. <i>Salvia</i> | |

Personalizzazione

SPROUT™ MATITA DI GRAFITE

53062

A LE
B DG

MOQ 500 pz.
MOQ 1000 pz. (Matita + confezione in cartoncino personalizzata)

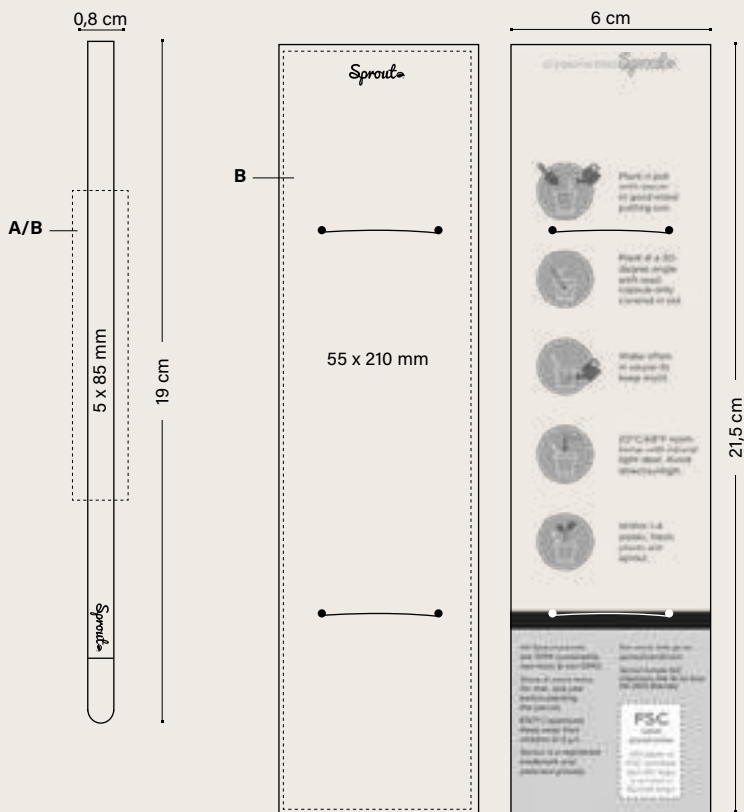

*Istruzioni per piantare incluse sul retro.
Possibilità di personalizzare
il cartoncino cambiando caratteri e colori!*

IMBALLAGGIO ESTERNO



500 ± 2,5 KG (SOLO MATITA)
± 5 KG (CON IMBALLO IN CARTONE)

IMBALLAGGIO



MARCATURA



Sprout



FSC E CARTONE
RICICLABILE



RICICLABILE

MODALITÀ
DI SCRITTURA



MATITA PC HB
Ø 2,3MM

TECNICHE DI
STAMPA



LASER



DIGITALE



GUARDA IL VIDEO

Vedere pagina 233 per una spiegazione dettagliata delle icone.

BASIC PEN

BASIC PEN

12010

Colore inchiostro



Personalizzazione

BASIC PEN 12010

A/B SP: max. 1 col.

MOQ 500 pz.

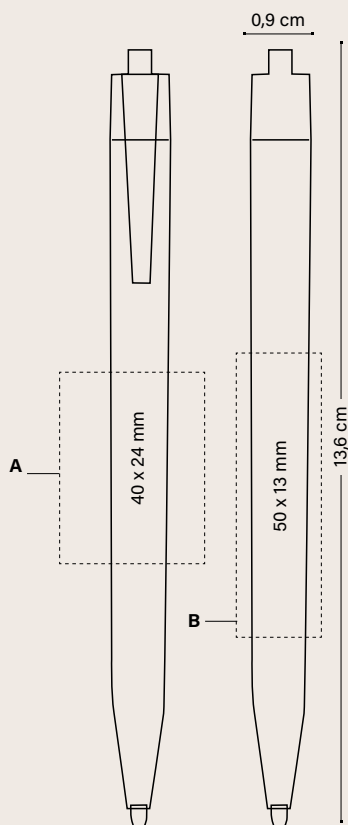

BASIC PEN 12010	Prezzo (€)			
	500-999	1000-2499	2500-4999	5000
Neutro	0,16	0,15	0,15	0,14
SP	0,65	0,51	0,44	0,40

I prezzi includono serigrafia ad un colore in una posizione.

IMBALLAGGIO ESTERNO



1000 ± 12,5 KG

MARCATURA



STAMPATO NEGLI
STABILIMENTI BIC



QUALITÀ E SICUREZZA
APPROVATO



CONFORMITÀ
NORMATIVA



MODALITÀ DI SCRITTURA



PENNA A SFERA M

TECNICHE DI STAMPA



SERIGRAFIA

CLICK PEN

CLICK PEN

11748

Colore inchiostro



01



03



24



04



05



02



10

100%

Personalizzazione

CLICK PEN

11748

A/B SP: max. 4 col.

C/D PD: max. 4 col.

MOQ 500 pz.

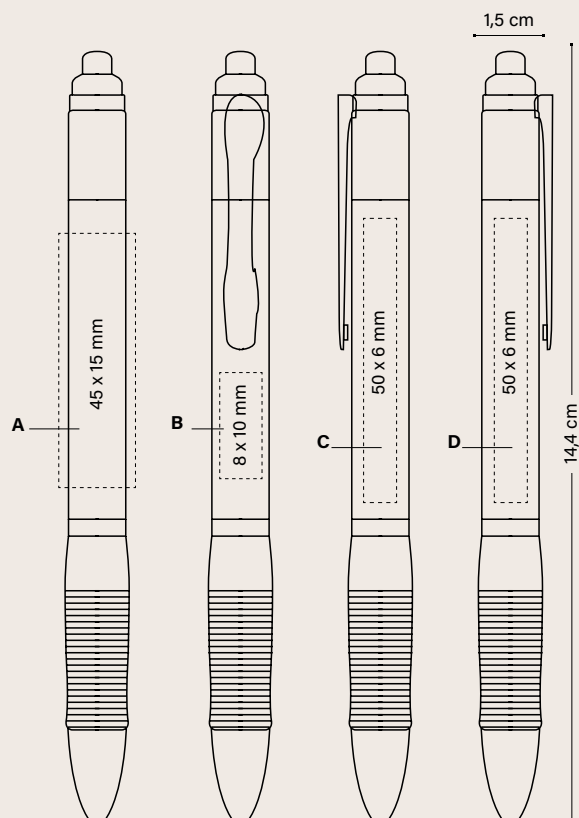

CLICK PEN	Prezzo (€)			
	500-999	1000-2499	2500-4999	5000
11748				
Neutro	0,21	0,20	0,20	0,19
SP	0,63	0,51	0,44	0,41
PD	0,77	0,61	0,52	0,48

Costo di stampa aggiuntivo per colore e posizione

SP	0,14	0,14	0,14	0,13
PD	0,37	0,27	0,20	0,19

I prezzi includono una stampa in una posizione secondo la tecnica specificata.

IMBALLAGGIO ESTERNO



MARCATURA



STAMPATO NEGLI STABILIMENTI BIC



QUALITÀ E SICUREZZA APPROVATO



CONFORMITÀ NORMATIVA



ISO certified



IMPRIM'VERT®

MODALITÀ DI SCRITTURA



PENNA A SFERA M

TECNICHE DI STAMPA



SERIGRAFIA



STAMPA A TAMPONE

STRIPED GRIP PEN

STRIPED GRIP PEN

11243

Colore inchiostro



10



03



24



8C



04
100%

Personalizzazione

STRIPED GRIP PEN

11243

A SP: max. 2 col.

B PD: max. 1 col.

MOQ 500 pz.

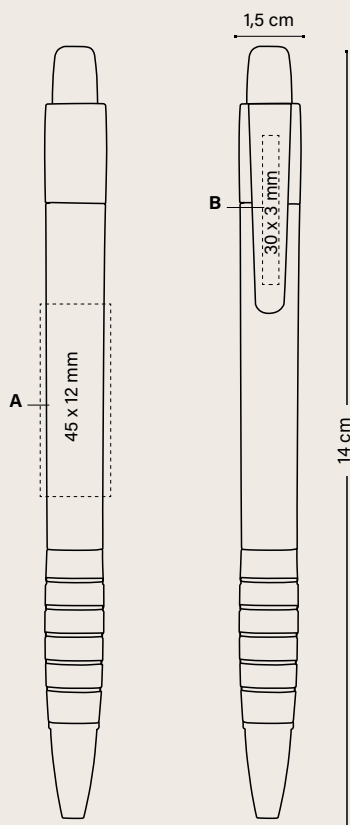

Prezzo (€)

STRIPED GRIP PEN	500-999	1000-2499	2500-4999	5000
11243				
Neutro	0,33	0,32	0,32	0,30
SP	0,74	0,62	0,55	0,51
PD	0,81	0,72	0,63	0,58

Costo di stampa aggiuntivo per colore e posizione

SP	0,14	0,14	0,14	0,13
PD	0,37	0,27	0,20	0,19

I prezzi includono una stampa in una posizione secondo la tecnica specificata.

IMBALLAGGIO ESTERNO



1000 ± 9 KG

MARCATURA



STAMPATO NEGLI STABILIMENTI BIC



QUALITÀ E SICUREZZA APPROVATO



CONFORMITÀ NORMATIVA



ISO certified
IMPRIM'VERT®

MODALITÀ DI SCRITTURA



PENNA A SFERA M

TECNICHE DI STAMPA



SERIGRAFIA



STAMPA A TAMPONE

SLEEK STYLUS PEN

SLEEK STYLUS PEN

11666

Colore inchiostro



01

SLEEK STYLUS MATT PEN

11747

Colore inchiostro



47



04

SLEEK STYLUS EXECUTIVE PEN

11976



26

Disponibile in
inchiostro blu



2N

Disponibile con
inchiostro nero

Personalizzazione

SLEEK STYLUS PEN

11666

SLEEK STYLUS MATT PEN

11747

SLEEK STYLUS EXECUTIVE PEN

11976

A SP: max. 1 col.

B SP: max. 2 col.

C LE

MOQ 500 pz. (SP)

MOQ 100 pz. (LE)

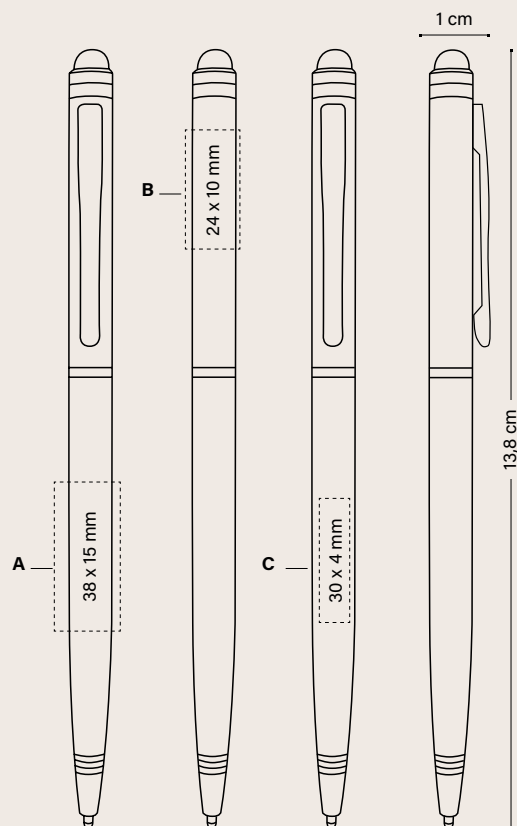

SLEEK STYLUS PEN	100-249	250-499	500-999	1000-2499	2500-4999	5000
11666						
Neutro	1,93	1,85	1,78	1,71	1,66	1,60
SP	-	2,55	2,34	2,15	2,09	1,94
LE	3,85	3,26	3,01	2,83	2,74	2,71

SLEEK STYLUS MATT PEN / EXECUTIVE PEN

11747 / 11976

Neutro	2,07	1,98	1,90	1,81	1,76	1,71
SP	-	2,68	2,46	2,26	2,19	2,05
LE	3,99	3,40	3,12	2,93	2,85	2,82

Costo di stampa aggiuntivo per colore e posizione

SP	-	0,39	0,34	0,23	0,23	①
LE	1,91	1,41	1,22	1,11	1,08	①

I prezzi includono una stampa in una posizione secondo la tecnica specificata.

① Prezzo su richiesta.

IMBALLAGGIO ESTERNO



(11666)
900 ± 12,4 KG



(11747 / 11976)
800 ± 13 KG

MARCATURA



STAMPATO NEGLI STABILIMENTI BIC



QUALITÀ E SICUREZZA APPROVATO



CONFORMITÀ NORMATIVA



ISO certified



IMPRIM'VERT®



PENNA A SFERA M

MODALITÀ DI SCRITTURA



STYLUS PEN

TECNICHE DI STAMPA



SP
SERIGRAFIA



LE
LASER

ROCKETBOOK®

Rocketbook® combina la libertà di un tradizionale taccuino di carta e penna a sfera con la sua app per inviare in modo veloce e sicuro gli appunti scritti a mano alla tua cartella Cloud. È stato progettato per essere l'ultimo quaderno di cui avrai bisogno. Segui le istruzioni incluse per la pagina bianca che potrai usare tutte le volte che vorrai. È possibile scegliere tra il modello Core per prendere appunti, tracciare grafici o disegnare, oppure fare un passo avanti con il modello Fusion per pianificare, elencare o fissare obiettivi.

Rocketbook® Core Executive A5

Rocketbook® Fusion Executive A5

Rocketbook® Core Mini A6



ROCKETBOOK® CORE EXECUTIVE A5



ROCKETBOOK® CORE EXECUTIVE A5
3728

Vincitore del premio POP 2022 per la miglior personalizzazione.



07
●
Navy blu



01
○
Bianco



02
●
Nero

-  *Scrivi*
-  *Scansiona*
-  *Condividi*
-  *Riutilizza*

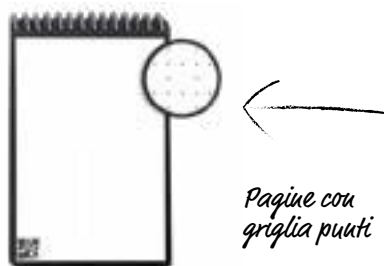

Pagine con griglia punti



Personalizzazione visibile nella finestra ritagliata

La confezione comprende sempre:

- quaderno
- penna a sfera
- panno
- istruzioni

Personalizzazione

ROCKETBOOK® CORE EXECUTIVE A5

3728

A SP: max. 1 col.

B BP: full-colour

C HS: max. 1 col.

36 pagine

MOQ 50 pz.

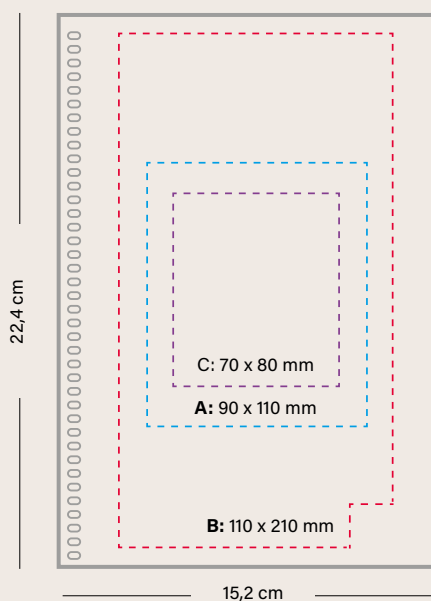

Prezzo (€)

ROCKETBOOK® CORE EXECUTIVE A5

3728

	50-99	100-249	250-499	500-999	1000
SP	34,33	32,12	29,23	27,53	26,68
HS	34,92	32,52	29,50	27,76	27,11
BP	39,26	35,02	31,96	30,08	28,44

I prezzi includono una stampa in una posizione secondo la tecnica specificata.

CONFEZIONI SPECIALI



GIFT BOX
CORE A5

IMBALLAGGIO ESTERNO



50 ± 5,8 KG

MARCATURA



STAMPATO NEGLI
STABILIMENTI BIC



CONFORMITÀ
NORMATIVA



IMPRIM'VERT®

APP ROCKETBOOK® DISPONIBILE IN



TECNICHE DI STAMPA



SERIGRAFIA



BRITEPIX™



HOT STAMPING



SCARICA L'APP



COME FUNZIONA

Vedere pagina 233 per una spiegazione dettagliata delle icone.

ROCKETBOOK® FUSION EXECUTIVE A5



ROCKETBOOK® FUSION EXECUTIVE A5
372

Vincitore del premio POP 2022 per la miglior personalizzazione.



01
○
Bianco



02
●
Nero



7 stili di pagina

- Pagine a righe
- Fogli puntinati
- Elenco delle attività
- Pianificatore settimanale
- Modello di obiettivo OKR
- Calendario mensile
- Elenco di idee

Personalizzazione visibile nella finestra ritagliata



La confezione comprende sempre:

- quaderno
- penna a sfera
- panno
- istruzioni

Personalizzazione

ROCKETBOOK® FUSION EXECUTIVE A5

3726

A SP: max. 1 col.

B BP: full-colour

C HS: max. 1 col.

42 pagine

MOQ 50 pz.

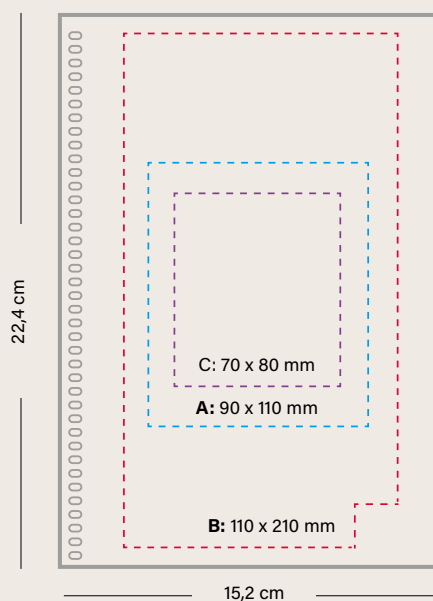

	Prezzo (€)				
ROCKETBOOK® FUSION EXECUTIVE A5	50-99	100-249	250-499	500-999	1000
3726					
SP	36,71	35,02	32,98	31,37	30,39
HS	37,30	35,41	33,30	31,58	30,59
BP	42,67	38,41	35,35	33,28	31,88

I prezzi includono una stampa in una posizione secondo la tecnica specificata.

CONFEZIONI SPECIALI



GIFT BOX FUSION A5

IMBALLAGGIO ESTERNO



50 ± 5,8 KG

MARCATURA



STAMPATO NEGLI STABILIMENTI BIC



CONFORMITÀ NORMATIVA



IMPRIM'VERT®

APP ROCKETBOOK® DISPONIBILE IN



TECNICHE DI STAMPA



SERIGRAFIA



BRITEPIX™



HOT STAMPING



SCARICA L'APP



COME FUNZIONA

Vedere pagina 233 per una spiegazione dettagliata delle icone.

ROCKETBOOK® CORE MINI A6



ROCKETBOOK® CORE MINI A6
3727

Vincitore del premio POP 2022 per la miglior personalizzazione.



01
●
Bianco



02
○
Nero



Scrivi



Scansiona



Condividi



Riutilizza

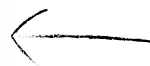
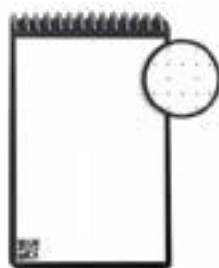

*Pagine con
griglia punti*

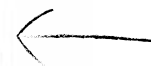

*Personalizzazione
visibile nella finestra
ritagliata*

La confezione comprende sempre:

- quaderno
- penna a sfera
- panno
- istruzioni

Personalizzazione

ROCKETBOOK® CORE MINI A6

3727

A SP: max. 1 col.

B BP: full-colour

C HS: max. 1 col.

48 pagine

MOQ 50 pz.

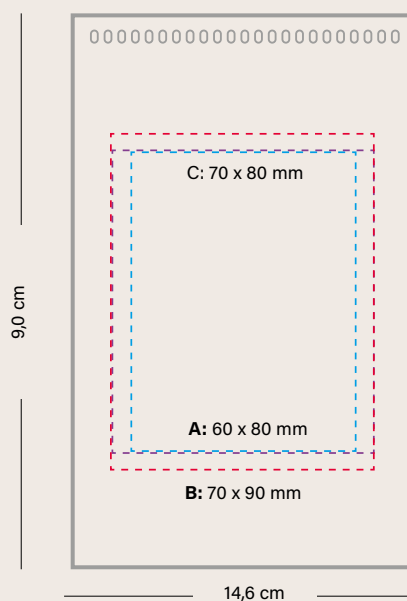

Prezzo (€)

ROCKETBOOK® CORE MINI A6	50-99	100-249	250-499	500-999	1000
3727					
SP	18,99	17,68	15,97	14,64	14,23
HS	19,41	18,07	16,24	15,30	14,74
BP	23,93	21,07	17,68	16,23	15,51

I prezzi includono una stampa in una posizione secondo la tecnica specificata.

CONFEZIONI SPECIALI



GIFT BOX
CORE A6

IMBALLAGGIO ESTERNO



50 ± 2,6 KG

MARCATURA



STAMPATO NEGLI
STABILIMENTI BIC



CONFORMITÀ
NORMATIVA



IMPRIM'VERT®

APP ROCKETBOOK®
DISPONIBILE IN



TECNICHE DI STAMPA



SERIGRAFIA



BRITEPIX™



HOT STAMPING



SCARICA L'APP



COME FUNZIONA

Vedere pagina 233 per una spiegazione dettagliata delle icone.



Accendini BIC®

La nostra qualità, la tua sicurezza

Tutti gli accendini tascabili BIC® soddisfano o eccedono i requisiti standard della norme di sicurezza internazionale. (ISO 9994, EN 13869, ASTM F400, US CPSC).

1/3 Meno di 1/3 dei modelli di accendini disponibili nel mercato Europeo **SODDISFANO** gli standard di sicurezza Europei¹.

3% Solo il 3% degli accendini elettronici disponibili in Europa sono **CONFORMI** allo standard EN 13869².



Altezza fiamma, resistenza alla caduta, stabilità della fiamma ed estinzione della fiamma sono alcune delle caratteristiche testate dallo standard ISO 9994.

¹Fonte: test realizzati da laboratori indipendenti accreditati tra il 2015 e il 2018.



Lo standard EN 13869 richiede che tutti gli accendini tascabili venduti in Europa siano effettivamente child-resistant per tutta la loro durata di vita.

²Fonte: test SGS su 105 modelli piezo a movimento verticale tra Aprile 2017 e Giugno 2018.

Un accendino child-resistant non è un accendino a prova di bambino.

Infatti, un accendino sicuro per i bambini è un accendino che almeno l'85% dei bambini di età inferiore a 51 mesi non è in grado di far funzionare. Ciò significa però che ben il 15% dei bambini potrebbe essere capace di azionare questo tipo di accendini. Per tale motivo, gli adulti dovrebbero sempre fare in modo che i bambini non possano impadronirsi di accendini, nemmeno qualora siano dotati di un dispositivo di sicurezza per i bambini.

SCEGLI BENE! tascabili BIC®



Accendino BIC® J25 Digital



Accendino BIC® J23 Digital



Accendino BIC® J26 Digital



Accendino BIC® J38 Digital





ACCENDINO BIC® J25



L'Iconico BIC® Boy
in rilievo

ACCENDINO BIC® J25

2360

2364 All Black



01 57 57 8G 03 11



59 24 04 25 25 06



90 84* 02 02 02 02

100%

Personalizzazione



ACCENDINO BIC® J25

2360/2364

A/C SP: max. 4 col.

MOQ 300 pz.

ACCENDINO BIC® J25 BRITPIX™

2360 / 2364

A/C BP: full-colour

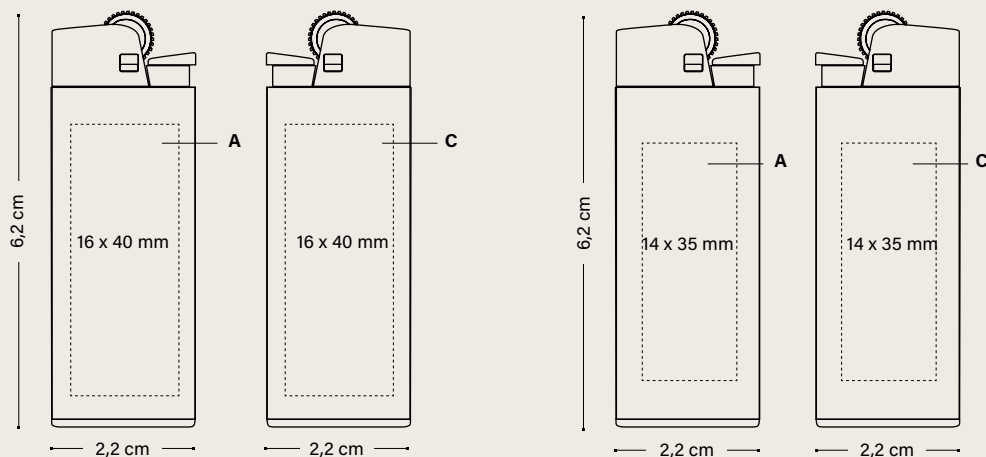

ACCENDINO BIC® J25	Prezzo (€)				
	300-599	600-1199	1200-2999	3000-5099	5100
2360					
SP	1,43	1,26	1,19	1,16	1,13
BP	1,69	1,51	1,43	1,39	1,34
2364					
SP	1,63	1,51	1,42	1,32	1,25
BP	1,91	1,75	1,64	1,54	1,46
Costo di stampa aggiuntivo per colore e posizione					
SP	0,15	0,14	0,14	0,14	0,11
BP	0,24	0,22	0,21	0,20	0,19

I prezzi della serigrafia includono un colore in una posizione.
I prezzi di britePix™ includono una stampa sul corpo.

IMBALLAGGIO



IMBALLAGGIO STANDARD:
IN VASSOIO DA 50 U

100% riciclata!



IMBALLAGGIO ESTERNO



600 ± 76 KG



FSC E CARTONE
RICICLABILE

MARCATURA



PRODOTTO E STAMPATO
NEGLI STABILIMENTI BIC



PRODOTTO
IN SPAGNA

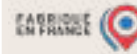

PASTELLO PRODOTTO
IN FRANCIA



CONFORMITÀ
NORMATIVA



FINO A 1.450



100 % ELETTRICITÀ
DA FONTI RINNOVABILI



BASSO IMPATTO
AMBIENTALE

TECNICHE DI STAMPA



SERIGRAFIA



BRITPIX™

Vedere pagina 233 per una spiegazione dettagliata delle icone.

FINITURE

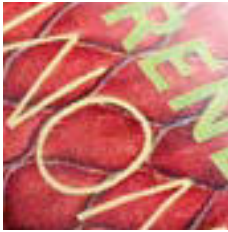

BR BRILLIANT



MT MATT

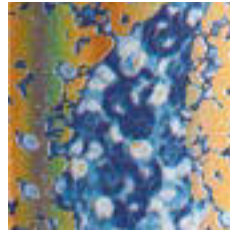

H HOLOGRAPHIC



P PUFFY



M METALLIC



UV UV



SA SANDY

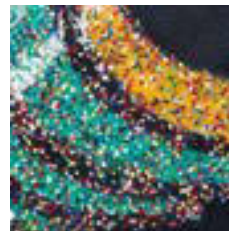

PG PUFFY GLITTER

ACCENDINO BIC® J25 DIGITAL
2360



MT MATT
P PUFFY



BR BRILLIANT
P PUFFY



MT MATT
M METALLIC

Stampa a 360°

100%

Personalizzazione

ACCENDINO BIC® J25 DIGITAL

2360

A DG: full-colour

MOQ 600 pz.

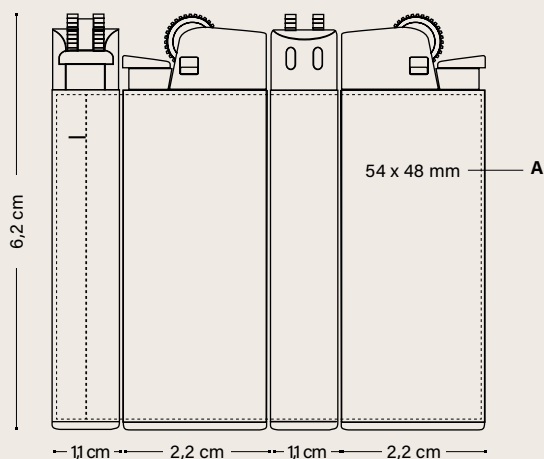

ACCENDINO BIC® J25 DIGITAL	300-599	600-1199	1200-2999	3000-5099	5100	Prezzo (€)
2360						
DG	-	1,88	1,76	1,66	1,56	

Costo aggiuntivo per finiture digitali						Quantità minima		
BR	MT	Brilliant o Matt	Gratuito			600 pz.		
	H	Holographic	-	0,27	0,27	0,24	0,19	600 pz.
	P	Puffy	-	-	-	0,24	0,19	3.000 pz.
	M	Metallic	①					50.000 pz.
	UV	UV	-	-	-	0,24	0,19	3.000 pz.
	SA	Sandy	-	-	-	0,24	0,19	3.000 pz.
	PG	Puffy Glitter	-	-	-	0,24	0,19	3.000 pz.

I prezzi includono stampa digitale sul corpo.

① Prezzo su richiesta.

IMBALLAGGIO



IMBALLAGGIO ESTÁNDAR:
EN BARQUETA DE 50 U.

¡100% riciclata!

IMBALLAGGIO ESTERNO



600 ± 7,6 KG



FSC E CARTONE
RICICLABILE

MARCATURA



PRODOTTO E STAMPATO
NEGLI STABILIMENTI BIC



PRODOTTO
IN SPAGNA



CONFORMITÀ
NORMATIVA



FINO A 1450



100 % ELETTRICITÀ
DA FONTI RINNOVABILI



BASSO IMPATTO
AMBIENTALE

TECNICHE DI STAMPA



DIGITALE

ACCENDINO BIC® J23



*L'iconico BIC® Boy
in rilievo*

ACCENDINO BIC® J23
2340



57



12



03



10

*Lunga durata: fino a
3.000 fiamme!*

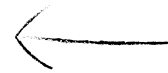

05



04



25



02

Personalizzazione

ACCENDINO BIC® J23

2340

A/C SP: max. 4 col.

MOQ 300 pz.

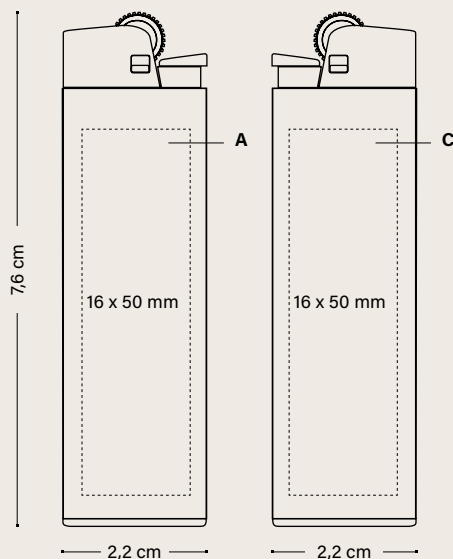

ACCENDINO BIC® J23

2340

SP

300-599 600-1199 1200-2999 3000-5099 5100

Prezzo (€)

	300-599	600-1199	1200-2999	3000-5099	5100
SP	1,56	1,43	1,34	1,26	1,22

Costo di stampa aggiuntivo per colore e posizione

SP	0,15	0,14	0,14	0,14	0,11
----	------	------	------	------	------

I prezzi includono serigrafia ad un colore in una posizione.

IMBALLAGGIO



IMBALLAGGIO ESTÁNDAR:
EN BARQUETA DE 50 U.

¡100% riciclata!

IMBALLAGGIO ESTERNO



600 ± 9,5 KG



FSC E CARTONE
RICICLABILE

MARCATURA



PRODOTTO E STAMPATO
NEGLI STABILIMENTI BIC



FABRICADO EN FRANCIA



CONFORMITÀ NORMATIVA



FINO A 1800



BASSO IMPATTO
AMBIENTALE

TECNICHE DI STAMPA



SERIGRAFIA

FINITURE



BR BRILLIANT



MT MATT

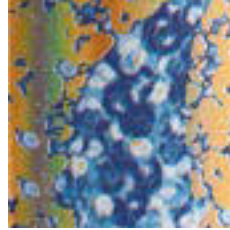

H HOLOGRAPHIC



P PUFFY



M METALLIC



UV UV



SA SANDY

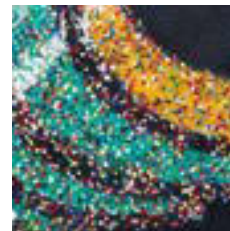

PG PUFFY GLITTER

ACCENDINO BIC® J23 DIGITAL
2340



MT MATT

P PUFFY

UV UV



MT MATT

M METALLIC



BR BRILLIANT

P PUFFY

Personalizzazione

ACCENDINO BIC® J23 DIGITAL

2340

A DG: full-colour

MOQ 600 pz.

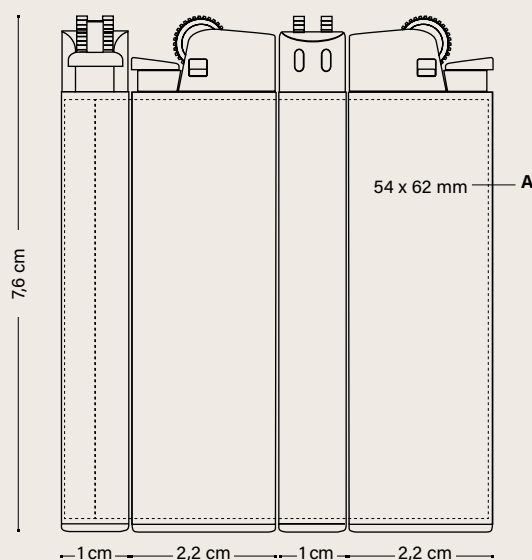

	Prezzo (€)				
ACCENDINO BIC® J23 DIGITAL	300-599	600-1199	1200-2999	3000-5099	5100
2340					
DG	-	2,04	1,93	1,84	1,74

		Costo aggiuntivo per finiture digitali					Quantità minima	
BR	MT	Brilliant o Matt	Gratuito				600 pz.	
	H	Holographic	-	0,27	0,27	0,24	0,19	600 pz.
	P	Puffy	-	-	-	0,24	0,19	3.000 pz.
	M	Metallic	①				50.000 pz.	
	UV	UV	-	-	-	0,24	0,19	3.000 pz.
	SA	Sandy	-	-	-	0,24	0,19	3.000 pz.
	PG	Puffy Glitter	-	-	-	0,24	0,19	3.000 pz.

I prezzi includono stampa digitale sul corpo.

① Prezzo su richiesta.

IMBALLAGGIO



IMBALLAGGIO ESTÁNDAR:
EN BARQUETA DE 50 U.

100% riciclata!

IMBALLAGGIO ESTERNO



600 ± 9,5 KG



FSC E CARTONE
RICICLABILE

MARCATURA



PRODOTTO E STAMPATO
NEGLI STABILIMENTI BIC

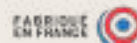

PRODOTTO IN FRANCE



CONFORMITÀ
NORMATIVA



FINO A 1.800



BASSO IMPATTO
AMBIENTALE

TECNICHE DI STAMPA



DIGITALE

ACCENDINO BIC® J26



L'iconico BIC® Boy
in rilievo

ACCENDINO BIC® J26
2320



01



57



8G



10



06

Lunga durata:
fino a 3.000
fiamme!

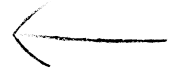

59



24



25



02



03

Personalizzazione

ACCENDINO BIC® J26

2320

A/C SP: max. 4 col.

MOQ 300 pz.

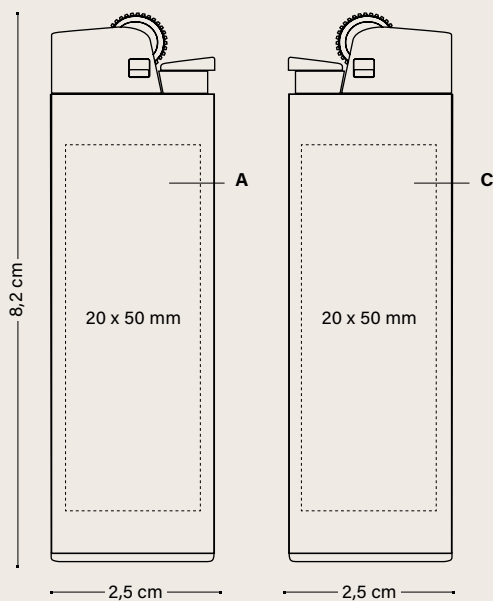

	Prezzo (€)				
ACCENDINO BIC® J26	300-599	600-1199	1200-2999	3000-5099	5100
2320					
SP	1,85	1,63	1,54	1,47	1,40

Costo di stampa aggiuntivo per colore e posizione

SP	0,15	0,14	0,14	0,14	0,11
-----------	------	------	------	------	------

I prezzi includono serigrafia ad un colore in una posizione.

IMBALLAGGIO



IMBALLAGGIO STANDARD:
EN BARQUETA DE 50 U.

¡100% riciclata!

IMBALLAGGIO ESTERNO



600 ± 15,1 KG



FSC E CARTONE
RICICLABILE

MARCATURA



PRODOTTO E STAMPATO
NEGLI STABILIMENTI BIC



PRODOTTO
IN SPAGNA



CONFORMITÀ
NORMATIVA



FINO A 3.000



100 % ELETTRICITÀ
DA FONTI RINNOVABILI



BASSO IMPATTO
AMBIENTALE

**TECNICHE DI
STAMPA**



SERIGRAFIA

Vedere pagina 233 per una spiegazione dettagliata delle icone.

FINITURE

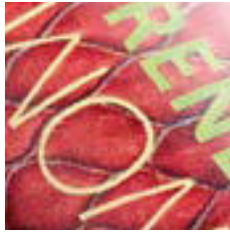

BR BRILLIANT



MT MATT

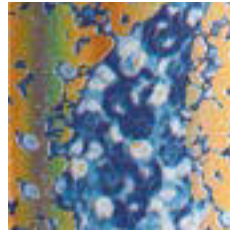

H HOLOGRAPHIC



P PUFFY



M METALLIC



UV UV



SA SANDY

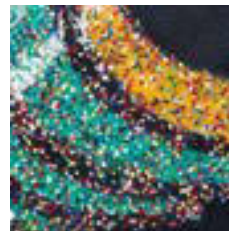

PG PUFFY GLITTER

ACCENDINO BIC® J26 DIGITAL
2320



BR BRILLIANT

M METALLIC



MT MATT

M METALLIC

P PUFFY



BR BRILLIANT

UV UV

H HOLOGRAPHIC

Personalizzazione

ACCENDINO BIC® J26 DIGITAL

2320

A DG: full-colour

MOQ 600 pz.

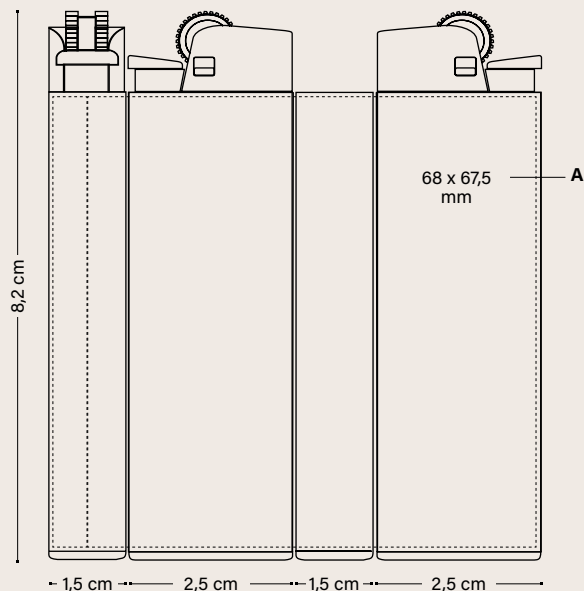

Prezzo (€)

ACCENDINO BIC® J26 DIGITAL	300-599	600-1199	1200-2999	3000-5099	5100
2320					
DG	-	2,38	2,26	2,14	1,98

Costo aggiuntivo per finiture digitali

						Quantità minima		
BR	MT	Brilliant o Matt	Gratuito			600 pz.		
	H	Holographic	-	0,27	0,27	0,24	0,19	600 pz.
	P	Puffy	-	-	-	0,24	0,19	3.000 pz.
	M	Metallic	①					50.000 pz.
	UV	UV	-	-	-	0,24	0,19	3.000 pz.
	SA	Sandy	-	-	-	0,24	0,19	3.000 pz.
	PG	Puffy Glitter	-	-	-	0,24	0,19	3.000 pz.

I prezzi includono stampa digitale sul corpo.

① Prezzo su richiesta.

IMBALLAGGIO



IMBALLAGGIO ESTÁNDAR:
EN BARQUETA DE 50 U.

¡100% riciclata!

IMBALLAGGIO ESTERNO



600 ± 15,1 KG



FSC E CARTONE
RICICLABILE

MARCATURA



PRODOTTO E STAMPATO
NEGLI STABILIMENTI BIC



PRODOTTO
IN SPAGNA



CONFORMITÀ
NORMATIVA



FINO A 3.000



100 % ELETTRICITÀ
DA FONTI RINNOVABILI



BASSO IMPATTO
AMBIENTALE

TECNICHE DI STAMPA



DIGITALE

ACCENDINO BIC® J38

 *L'iconico BIC® Boy
in rilievo*

ACCENDINO BIC® J38
2452



57



25



02



03

100%

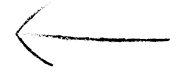

*Illuminazione
elegante e
confortevole!*

Personalizzazione

ACCENDINO BIC® J38

2452

A/C SP: max. 4 col.

MOQ 300 pz.

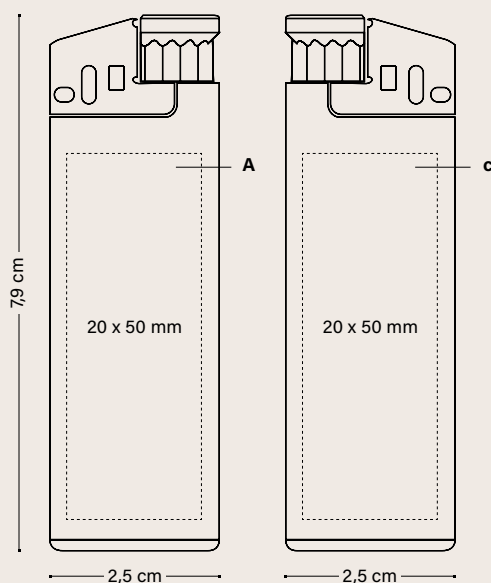

ACCENDINO BIC® J38	300-599	600-1199	1200-2999	3000-5099	Prezzo (€)
2452					5100
SP	1,99	1,90	1,81	1,73	1,64

Costo di stampa aggiuntivo per colore e posizione

SP	0,15	0,14	0,14	0,14	0,11
----	------	------	------	------	------

I prezzi includono serigrafia ad un colore in una posizione.

IMBALLAGGIO



IMBALLAGGIO ESTÁNDAR:
EN BARQUETA DE 50 U.

¡100% riciclata!

IMBALLAGGIO ESTERNO



600 ± 13,2 KG



FSC E CARTONE
RICICLABILE

MARCATURA



PRODOTTO E STAMPATO
NEGLI STABILIMENTI BIC



PRODOTTO
IN SPAGNA



CONFORMITÀ
NORMATIVA



FINO A 1.800



100 % ELETTRICITÀ
DA FONTI RINNOVABILI



BASSO IMPATTO
AMBIENTALE

TECNICHE DI
STAMPA



SERIGRAFIA

Vedere pagina 233 per una spiegazione dettagliata delle icone.

FINITURE



BR BRILLIANT



MT MATT

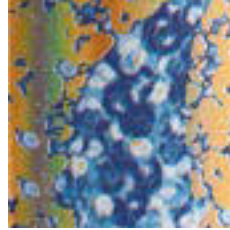

H HOLOGRAPHIC



P PUFFY



M METALLIC



UV UV



SA SANDY

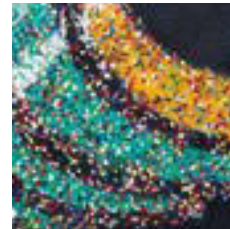

PG PUFFY GLITTER

ACCENDINO BIC® J38 DIGITAL
2452



57

BR BRILLIANT

PG PUFFY GLITTER



57

BR BRILLIANT

SA SANDY



57

BR BRILLIANT

Stampa a 360°

Personalizzazione

ACCENDINO BIC® J38 DIGITAL

2452

A DG: full-colour

MOQ 600 pz.

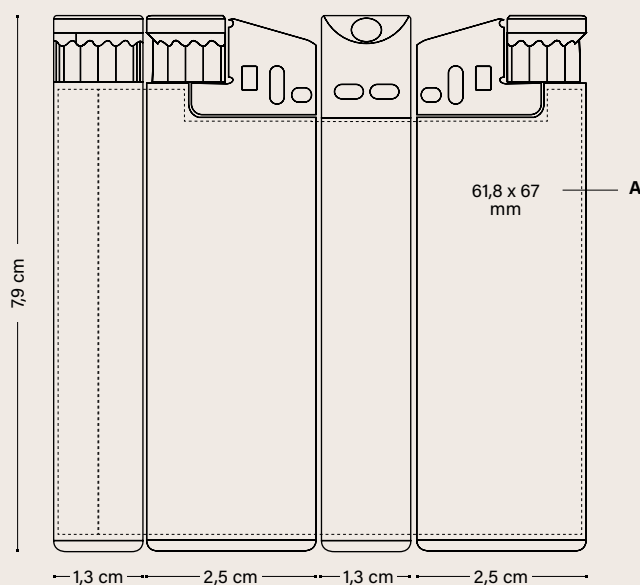

	Prezzo (€)				
ACCENDINO BIC® J38 DIGITAL	300-599	600-1199	1200-2999	3000-5099	5100
2452					
DG	-	2,18	2,08	1,98	1,88

Costo aggiuntivo per finiture digitali

						Quantità minima	
BR MT	Brilliant o Matt					Gratuito	600 pz.
H	Holographic					- 0,27 0,27 0,24 0,19	600 pz.
P	Puffy					- - - 0,24 0,19	3.000 pz.
M	Metallic					①	50.000 pz.
UV	UV					- - - 0,24 0,19	3.000 pz.
SA	Sandy					- - - 0,24 0,19	3.000 pz.
PG	Puffy Glitter					- - - 0,24 0,19	3.000 pz.

I prezzi includono stampa digitale sul corpo.

① Prezzo su richiesta.

IMBALLAGGIO



IMBALLAGGIO ESTÁNDAR:
EN BARQUETA DE 50 U.

100% riciclata!

IMBALLAGGIO ESTERNO



600 ± 13,2 KG



FSC E CARTONE
RICICLABILE

MARCATURA



PRODOTTO E STAMPATO
NEGLI STABILIMENTI BIC



PRODOTTO
IN SPAGNA



CONFORMITÀ
NORMATIVA



FINO A 1.800



100 % ELETTRICITÀ
DA FONTI RINNOVABILI



BASSO IMPATTO
AMBIENTALE

TECNICHE DI STAMPA



DIGITALE

COVER BIC® STYL'IT LUXURY

COVER BIC® STYL'IT LUXURY 2386 Neon



TUTTE LE COVER
vengono consegnate
con un accendino
BIC® J25 bianco!



59*



1G*



100%

5C*

Personalizzazione

COVER BIC® STYL'IT LUXURY 2386

MOQ 100 pz.
A/C LE

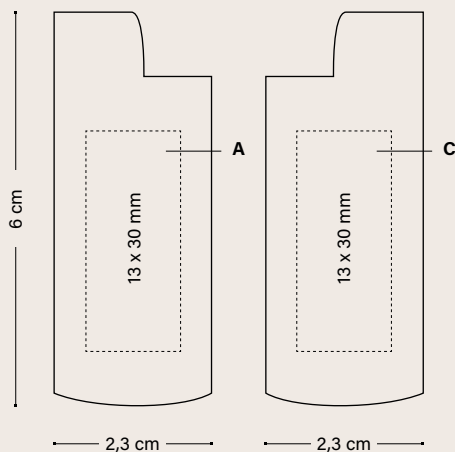

MOQ 100 pz.
A/C PD

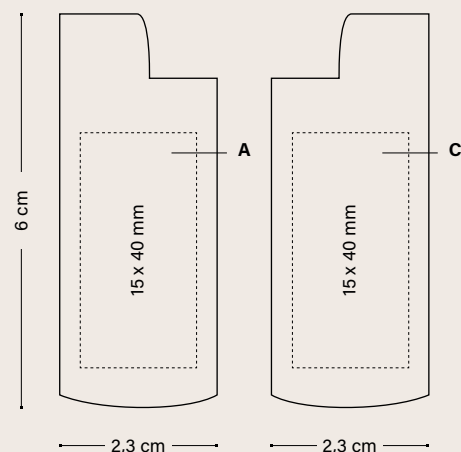

	Prezzo (€)			
COVER BIC® STYL'IT LUXURY NEON	100-299	300-599	600-1199	1200-2999
2386				
PD	3,02	2,66	2,52	2,39
LE	4,31	4,11	3,85	3,72

Costo di stampa aggiuntivo per colore e posizione

PD	0,29	0,25	0,18	0,18
LE	1,21	1,09	0,96	0,96

I prezzi includono una stampa in una posizione secondo la tecnica specificata.

CONFEZIONI



CONFEZIONI ESTÁNDAR:
EN BARQUETA DE 10 U.

IMBALLAGGIO ESTERNO



300 ± 6,1 KG



FSC E CARTONE
RICICLABILE

MARCATURA



STAMPATO NEGLI
STABILIMENTI BIC



CONFORMITÀ
NORMATIVA



TECNICHE DI STAMPA



STAMPA A
TAMPONE



LASER

COVER BIC® STYL'IT LUXURY
2153 Soft



*TUTTE LE COVER
vengono consegnate
con un accendino
BIC® J25 bianco!*



47*

Personalizzazione

COVER BIC® STYL'IT LUXURY

2153

A/C LE

MOQ 100 pz.

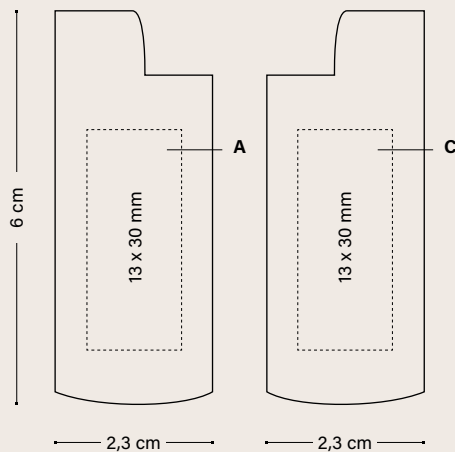

	Prezzo (€)			
	100-299	300-599	600-1199	1200-2999
COVER BIC® STYL'IT LUXURY SOFT				
2153				
LE	4,52	4,37	4,18	4,02
Costo di stampa aggiuntivo per colore e posizione				
LE	1,21	1,09	0,96	0,96

I prezzi includono una incisione laser in una posizione.

CONFEZIONI



CONFEZIONI ESTÁNDAR:
EN BARQUETA DE 10 U.

IMBALLAGGIO ESTERNO



300 ± 6,1 KG



FSC E CARTONE
RICICLABILE

MARCATURA



STAMPATO NEGLI
STABILIMENTI BIC



CONFORMITÀ
NORMATIVA



TECNICHE DI STAMPA



LASER

*Fino ad esaurimento scorte. Vedere pagina 233 per una spiegazione dettagliata delle icone.

COVER BIC® ALUMINIUM FLAT

COVER BIC® ALUMINIUM FLAT 2156

3 lati
personalizzabili!



TUTTE LE COVER
vengono consegnate
con un accendino
BIC® J25 bianco!



47*



03*

Personalizzazione

COVER BIC® ALUMINIUM FLAT 2156

MOQ 100 pz.
A/C PD: max. 1 col.

MOQ 100 pz.
A/B/C BP: full-colour

MOQ 100 pz.
A/B/C LE

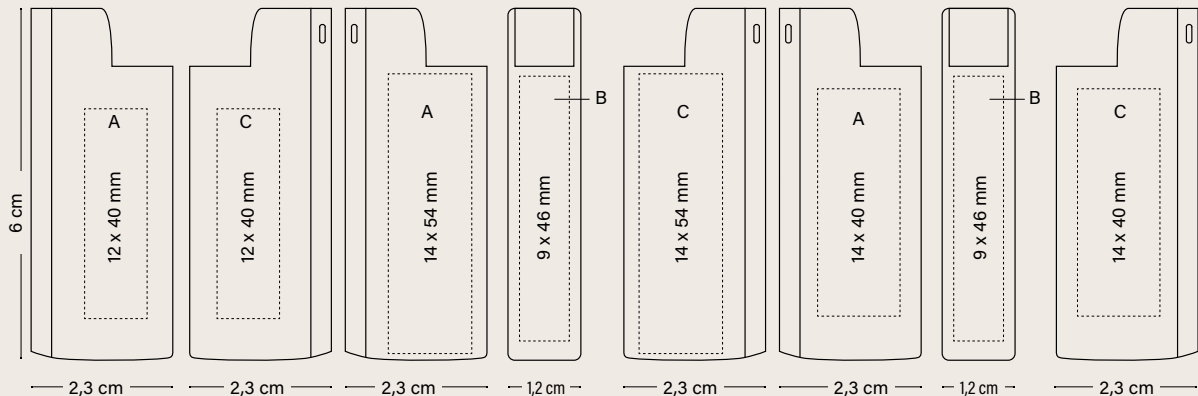

COVER BIC® ALUMINIUM FLAT 2156	Prezzo (€)			
	100-299	300-599	600-1199	1200-2999
PD	1,93	1,85	1,76	1,67
BP	2,14	2,06	1,95	1,86
LE	3,10	2,93	2,71	2,63

Costo di stampa aggiuntivo per colore e posizione

PD	0,29	0,25	0,18	0,18
BP	0,25	0,22	0,20	0,19
LE	1,21	1,09	0,96	0,96

I prezzi includono una stampa in una posizione secondo la tecnica specificata.

CONFEZIONI



CONFEZIONI ESTÁNDAR:
EN BARQUETA DE 50 U.

IMBALLAGGIO ESTERNO



300 ± 6,9 KG



FSC E CARTONE
RICICLABILE

ESPECIFICACIONES



STAMPATO NEGLI
STABILIMENTI BIC



CONFORMITÀ
NORMATIVA



TECNICHE DI STAMPA



STAMPA A
TAMPONE



BRITEPIX™
BRITEPIX™ PERSONALISATION

COVER BIC® CLIP 2398



TUTTE LE COVER
vengono consegnate
con un accendino
BIC® J25 bianco!



03*



02*



100%

Personalizzazione

COVER BIC® CLIP 2398

MOQ 100 pz.
A/C PD: max. 1 col.

MOQ 100 pz.
A/C BP: full-colour
BP Texture: full-colour

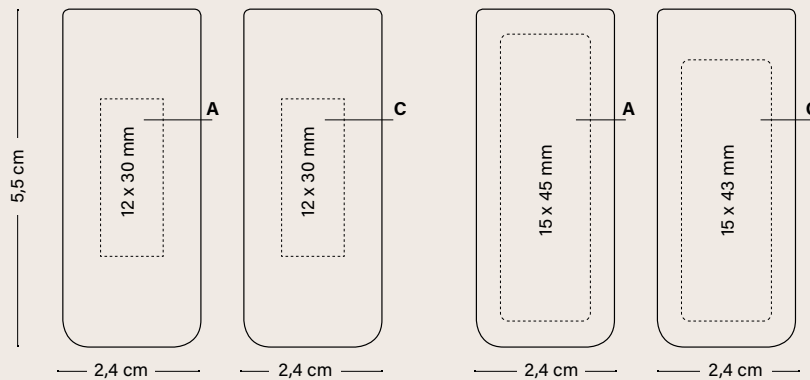

COVER BIC® CLIP 2398	Prezzo (€)			
	100-299	300-599	600-1199	1200-2999
PD	1,55	1,44	1,32	1,29
BP	1,76	1,65	1,52	1,47

Costo di stampa aggiuntivo per colore e posizione

PD	0,29	0,25	0,18	0,18
BP	0,25	0,22	0,20	0,19
BP Texture	0,19	0,17	0,15	0,14

I prezzi includono una stampa in una posizione secondo la tecnica specificata.

CONFEZIONI



CONFEZIONI ESTÁNDAR:
EN BARQUETA DE 50 U.



300 ± 7,5 KG



FSC E CARTONE
RICICLABILE

ESPECIFICACIONES



STAMPATO NEGLI
STABILIMENTI BIC



CONFORMITÀ
NORMATIVA



TECNICHE DI STAMPA



STAMPA A
TAMPONE



BRITEPIX™
BRITEPIX™ PERSONALISATION

COVER BIC® 3D 2395



*TUTTE LE COVER
vengono consegnate
con un accendino
BIC® J25 bianco!*



*Converti il tuo logo
in una forma 3D!*

Personalizzazione

COVER BIC® 3D

2395

A/C 3D: max. 6 col.

MOQ 1.200 pz.

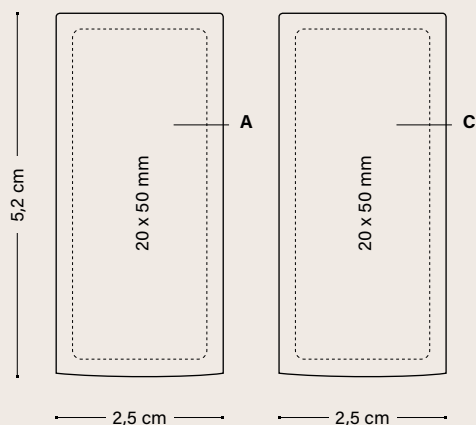

	Prezzo (€)		
COVER BIC® 3D	1200-2999	3000-5099	5100
2395			
3D	4,79	4,53	4,31

Costo di stampa aggiuntivo per colore e posizione

Stampa 3D in rilievo sul lato C (1 colore)	0,17	0,15	0,15
---	------	------	------

Colori in rilievo aggiuntivi	0,10	0,09	0,09
-------------------------------------	------	------	------

I prezzi includono la stampa 3D ad un colore in una posizione.

CONFEZIONI



CONFEZIONI ESTÁNDAR:
EN BARQUETA DE 50 U.

IMBALLAGGIO ESTERNO



300 ± 7,5 KG



FSC E CARTONE
RICICLABILE

MARCATURA



CONFORMITÀ
NORMATIVA



TECNICHE DI STAMPA



EMBOSSING

POSACENERE TASCABILE BIC®

POSACENERE TASCABILE BIC®
3850

6 diverse forme
di linguetta
disponibili

Riutilizzabile ed
ermetico



Personalizzazione

POSACENERE TASCABILE BIC®
3850

A SP: max. 5 col. (max.2 colori per ordini inferiori a 20.000 pz.)

MOQ 5.000 pz.

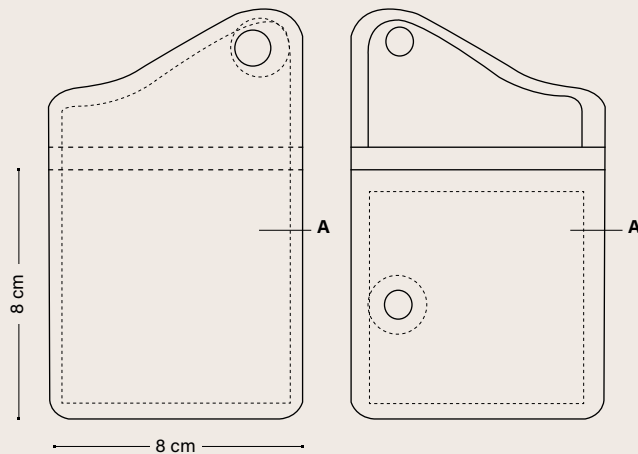

	Prezzo (€)			
	5000-9000	10000-24999	25000-49999	50000
POSACENERE TASCABILE BIC®				
3850				
SP	0,97	0,85	0,70	0,64

Costo di stampa aggiuntivo per colore e posizione				
SP	0,04	0,03	0,03	0,03

I prezzi includono la serigrafia ad un colore in una posizione e il testo legale.

CONFEZIONI



SCATOLA PER 10 PZ. OGNI POSACENERE TASCABILE BIC® VIENE FORNITO IN UN CELLOPHANE INDIVIDUALE.

IMBALLAGGIO ESTERNO



500 ± 5,5 KG

MARCATURA



CONFORMITÀ
NORMATIVA

TECNICHE DI STAMPA



SERIGRAFIA

POSACENERE TASCABILE BIC®
3851 Kraft

*Immagine rispettosa
dell'ambiente*

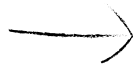

100%

Personalizzazione

**POSACENERE TASCABILE
KRAFT BIC®**

3851 Kraft

A SP: max. 2 col.

MOQ 10.000 pz.

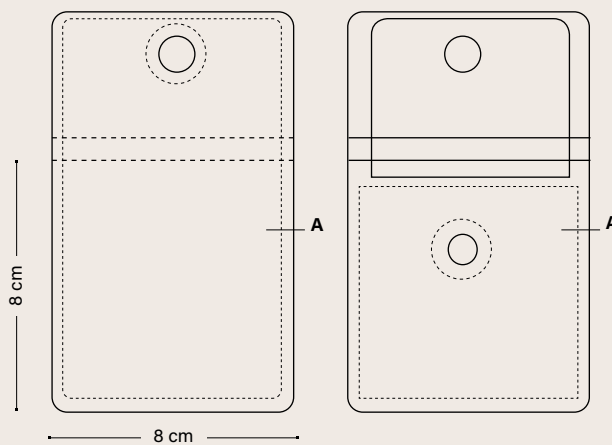

	Prezzo (€)		
POSACENERE TASCABILE BIC®	10000-24999	25000-49999	50000
3851			
SP	1,04	0,86	0,80

Costo di stampa aggiuntivo per colore e posizione			
SP	0,03	0,03	0,03

I prezzi includono la serigrafia ad un colore in una posizione e il testo legale.

CONFEZIONI

IMBALLAGGIO ESTERNO



SCATOLA PER 10 PZ. OGNI POSACENERE TASCABILE BIC® VIENE FORNITO IN UN CELLOPHANE INDIVIDUALE.



500 ± 5,5 KG

MARCATURA



CONFORMITÀ
NORMATIVA

TECNICHE DI STAMPA



SERIGRAFIA

CONFEZIONI BIC® ECOLUTIONS®



NUOVO!

BIC® COLLECTION BOX

Scatola in cartone FSC. Personalizzabile su ogni lato, offre grandi superfici di comunicazione. Ideale per presentare i nostri iconici prodotti BIC® in una collezione. Più che una penna, un ottimo modo per ottimizzare le tue vendite.

	Prezzo (€)					
	100-249	250-499	500-999	1000-2499	2500-4999	5000
991212 1 unità	9,50	4,25	2,50	1,65	1,20	1,00
991213 2 unità	12,20	6,25	3,75	2,50	2,20	1,85
991214 3 unità	13,50	7,00	4,70	3,65	3,10	2,80



Confezione speciale per:



- BIC® 4 COLOURS®
- BIC® WIDE BODY™
- BIC® SUPER CLIP
- BIC® BRITELINER® GRIP
- BIC® GRIP ROLLER



FSC E CARTONE RICICLABILE

BIC® ECO SLEEVE

985240

Astuccio riciclato opzionale per tutti gli strumenti di scrittura BIC® eccetto le matite.

Prezzo (€)
0,24



CARTONE RICICLATO



Confezione speciale per penne con clip stampata:



- BIC® MEDIA CLIC
- BIC® CLIC STIC
- BIC® SUPER CLIP
- BIC® WIDE BODY™
- BIC® INTENSITY® GEL CLIC
- BIC® XS FINE STYLE

BIC® WINDOW BOX

985241

Astuccio dal design premiun adatto a tutti gli strumenti di scrittura BIC® eccetto le matite.

Prezzo (€)
1,44



FSC E CARTONE
RICICLABILE



Confezione speciale per:



BIC® METAL PENS



BIC® PLASTIC POUCH

985242

Design speciale per questa confezione adatta per ogni strumento di scrittura e per 3 matite.

Prezzo (€)
0,45



FSC E CARTONE
RICICLABILE



PLASTICA
RICICLABILE



Usami come
segualibro



BIC® MARKING SET

985243

Confezione adatta a ogni pennarelli.

Prezzo (€)
0,71



FSC E CARTONE
RICICLABILE



PLASTICA
RICICLABILE



Confezione speciale per:



3 BIC® BRITE LINER® GRIP
3 BIC® MARK-IT



3 BIC® VELLEDA® GRIP
3 BIC® VELLEDA® FINE

Usami come
segualibro



MARCATURA



PRODOTTO
IN SPAGNA



CONFORMITÀ
NORMATIVA



ecolutions®



DAI UN'OCCHIATA
ALL' INIZIATIVA
TREETEDOM®



Cello wrap 1 unità



Cello wrap 2 unità

BIC® CELLO WRAP		Prezzo (€)
1 unità - 971634		0,18
2 unità - 971635		0,35
3 unità - 971636		0,50
4 unità - 971637		0,68

Non disponibile per matite in grafite né per penne metalliche.

BIC® BLACK VELVET POUCH 1 UNITÀ
974216

Esclusiva confezione in velluto per 1 o 2 strumenti di scrittura.
Particolarmente indicata per penne in metallo.

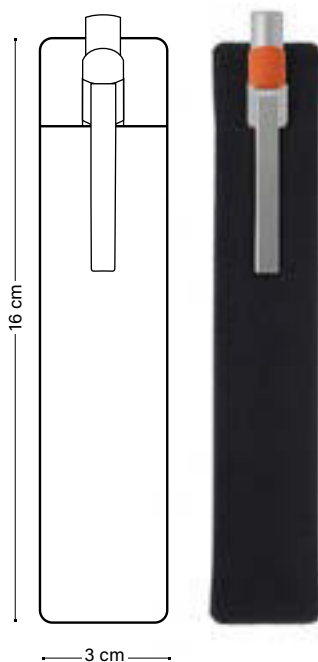

BIC® BLACK VELVET POUCH 1 UNITÀ		Prezzo (€)
1 unità		0,51

Disponibile per tutti gli strumenti di scrittura
eccetto matite in grafite e portamine.

BIC® CARTON BLACK&SILVER COLOUR GIFT BOX

974218*

Scatoletta per tutti gli strumenti di scrittura, matite escluse.

Prezzo (€)
0,35



BIC® FROSTED POUCH (PER 1 O 2 UNITÀ)

971640*

Confezione trasparente per 2 strumenti di scrittura.

A SP: max. 1 col.

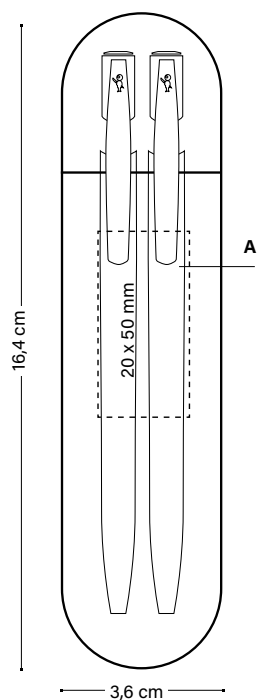
Disponibile per 1 o 2 strumenti di scrittura (sottili) BIC®
eccetto: matite in grafite, BIC® Matic® Grip.

BIC® FROSTED POUCH Prezzo (€)
0,87

Costo di stampa aggiuntivo per colore e posizione

SP 0,47

Disponibile per 1 o 2 strumenti di scrittura (sottili) BIC®
eccetto: matite in grafite e portamine.

TECNICHE DI STAMPA

SP SERIGRAFIA

BIC® SEE-THROUGH GIFT BOX (PER 1 O 2 UNITÀ)

974599*

Scatoletta per tutti gli strumenti di
scrittura, matite escluse, con finestrella.

Prezzo (€)
1,97



COUNT BOX

Piccola (per 25 BIC® Clic Stic)

Media (per 50 BIC® Media Clic o strumenti di scrittura delle stesse dimensioni)

Grande (solo per 100 BIC® Ecolutions® Evolution)



	Prezzo (€)
Piccola	0,85
Media	1,19
Grande	1,64

PLASTIC BAG

Piccola (per 25 BIC® Media Clic o strumenti di scrittura delle stesse dimensioni)

Media (per 50 BIC® Media Clic o strumenti di scrittura delle stesse dimensioni)

Grande (per 100 BIC® Media Clic o strumenti di scrittura delle stesse dimensioni)



	Prezzo (€)
Piccola	0,58
Media	1,13
Grande	1,69

TRAY OF 10 WRITING INSTRUMENTS



Prezzo (€)
1,91

COUNT BOX 10U. COVER

976382



Prezzo (€)
1,00

Disponibile per Accendini BIC® J26, BIC® J38, BIC® J23 e BIC® J25.

COUNT BOX 10U. COVER CHILD RESISTANT

976403



Prezzo (€)
1,00

Disponibili per Accendini BIC® J26, BIC® J38, BIC® J23 e la famiglia Cover BIC® Styl'it Luxury.

COUNT BOX 10U. J25 CHILD RESISTANT

974635



Prezzo (€)
0,78

Disponibile per accendino BIC® J25.

BOX OF 50U. METAL STYL'IT COVER

977852



Prezzo (€)
4,48

Disponibile per Cover BIC® Clip, Cover BIC® 3D e Cover BIC® Flat

BIC® OUTER BOXES

Cartone esterno con design speciale per tutti gli strumenti di scrittura.



FSC E CARTONE RICICLABILE



PRODOTTO IN SPAGNA

BIC® OUTER BOXES

Disegno speciale per la scatola di accendini.



FSC E CARTONE RICICLABILE



PRODOTTO IN SPAGNA

TRAY OF 50 BIC® LIGHTERS



100% RICICLATA

